



Test & Measurement Equipment Catalog





As the pioneer in radio frequency (RF) measurements dating back to the 1940's, Bird is excited to be at the forefront of yet another remarkable and enviable accomplishment; the celebration of its 80th year in business.

The RF test and measurement industry has certainly evolved since J. Raymond Bird first invented his RF wattmeter in 1942. Today, Bird continues to help customers test, measure, monitor and invent on a broader and deeper scale. Our newest products, featured in the first pages of our 2023 catalog, have been developed with ingenuity, precision, and simplicity in mind to meet the emerging challenges of the RF test and measurement industry.



1942

Slotted line used to develop Bird's very first terminating wattmeter, the **TS-70**.



1952

Oil and water-cooled load families expand



1978

Pushing the accuracy bar to 3% with the new 4421 power meter.



1998

Wideband sensors easily measure complex waveforms from digital TV, cellular and radio



2019

Bird Engineering Company was founded in 1942 by J. Raymond Bird

1948



Bird introduced the standard on which all future wattmeters would be judged – the **Model 43 Thruline Wattmeter**.

1960's



World's first microprocessor controlled Model 4381 directional wattmeter

1986



First handheld antenna & cable tester simplifies RF testing

2000's



0.5% precision pulse & CW sensors push the accuracy envelope for Semiconductor

Contents



RF ANALYZERS

SiteHawk™ Cable & Antenna Analyzer.....	14
SignalHawk™ Spectrum Analyzer.....	15
Master RF Test Kits	16
FlightHawk™ Aviation Cable & Antenna Analyzer Kits.	18
RailHawk™ Railway Cable & Antenna Analyzer Kit ...	19

PRECISION RF PRODUCTS

Multifunction Power Meter	23
RF Power Sensors	24
Bird Diagnostic System	30
Calibration Carts.....	32
RF Calibration Kit	37

RF POWER SENSORS

RF Power Meter Display	41
Wideband Power Sensors.....	42
Basic Power Sensors.....	44
Statistical Power Sensor	45
Directional Power Sensors	46

RF POWER MONITORS

Channel Power Monitors	51
Transmitter Power Monitor	54
Broadcast Power Monitor.....	56
RF Monitors & Alarms	58

RF POWER METERS

Portable Wattmeters	62
Panel Mount Wattmeters	68
Rigid Line Sections.....	70
Field Replacement Meter	71
Plug-In Elements.....	73

RF LOADS & ATTENUATORS

Conduction-Cooled Loads.....	83
Convection-Cooled Loads	84
Oil-Cooled Loads	86
Market Specific Oil Loads.....	88
Water-Cooled Loads.....	89
Digital Air-Cooled Loads.....	90
Moduloads	92
Oil Convection-Cooled Attenuators	93
Convection-Cooled Attenuators.....	94

ACCESSORIES

Passive Components	97
Variable RF Signal Samplers.....	102
Coaxial Selector Switches.....	103
QC Connectors	104
Adapters & Connectors.....	105
RF Connector & Adapter Kits	106
Protective Cases	109
Coaxial Cables	110
Load & Cooling Accessories	111

SOFTWARE

RF Meter App.....	113
Virtual RF Meter Software (VPM3)	113
Windows®10 RF Meter App	114

INDEX

Index	115
-------------	-----

Discover RF with Bird

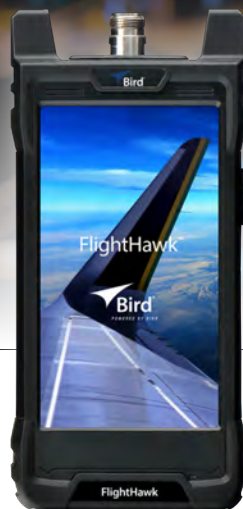

SignalHawk™ Spectrum Analyzers

SH-60S-AOA, SH-60S-TC

- SH-60S-AOA leverages mapping technology from OpenStreetMap allowing users to triangulate the source.
- SH-60-TC- Spectrogram/Waterfall display shows intermittent power levels at a glance.
- Predefined measurements scan and discover spectrum events other analyzers miss.
- View the spectrum with trace display, spectrogram display, or both.

→ [Page 15](#)

FlightHawk™ Aviation Cable & Antenna Analyzer Kits

FH-AV-KIT, FH-AV-BASIC

- Locate opens, shorts, improper crimps, bends, moisture, loose connectors, and defective antenna elements that lead to weak or intermittent RF operations.
- Utilize the FDR technology to perform a VSWR test by transmitting a continuous RF sweep of the cables & antenna at their operating frequencies.
- Easy to use handheld tester, enabling the user to configure a Go/No-Go test by using the Pass/Fail, Limit Line, and Marker tools. This option can be used for a Measure/Match or Distance to Fault sweep.

→ [Page 18](#)

Multifunction Power Meter with Dual Sensor Inputs

4421A

- Compatible with the full line of Bird's 402x-Series power sensors
- Automatic sensor detection for seamless integration
- Large 9.7 in full color LCD touchscreen display for easy readability
- Dual sensor option expands measurement capabilities
- Compact, lightweight and portable design enhances functionality

→ [Page 23](#)



Precision RF Sensors for Semiconductor Applications

7027 & 7037 SERIES

- Capable of $\pm 0.5\%$ and $\pm 1\%$ power measurement accuracy
- Measure pulse state widths down to 1 μ s (sensor dependent)
- Measure pulse rep. rates from 10 Hz up to 100 kHz
- Gated power measurements with up to four sets of gates available
- Time domain display
- Automate with SCPI command set
- Harmonic filtering
- External sync input
- NIST traceable calibration

→ [Page 24 - 25](#)



Ethernet Power Sensors

4042E & 4043E SERIES

- Remote monitoring of radio communication systems
- Ethernet, webserver, SNMP
- Measure total RMS power of all signals
- Measure select frequencies, up to 16 channels
- Selectable frequency and bandwidth for each channel
- Alarming on VSWR, low & high power

→ [Page 53](#)



RF Power Meter Display

5000-NG

- Rugged, 8" color touch screen display for worry-free field use
- Automatic sensor detection that works with 10 supported Bird field USB sensors
- 48 hours of battery life for extended use
- 5.0 Megapixel camera to document equipment serial numbers and model number for warranty documentation and installation validation
- Tried and true power measurement with simple set-up
- Data logging, numerical & graphics display
- Easy data transfer via USB or WiFi

→ [Page 41](#)



SERVICES

Expertise, Support, and Traceability With the Bird Service Center

The Bird Service Center located in Solon, Ohio is an A2LA Accredited Laboratory which provides RF calibration, repair and support services. With years of combined experience, our skilled technicians and product experts offer reliable service and customer care. Our worldwide network of service centers and service partners provide the best solution for maintaining the high level of performance, calibration, and RF repair for all of your Bird products.



REPAIR & CALIBRATION

Page 7



RF TRAINING & CERTIFICATION

Page 8



RF TECHNICAL SUPPORT

Page 8



EXTENDED WARRANTIES

Page 8



Repair & Calibration Services

Restore your instrument or equipment to original functionality, specifications and like-new condition, every time. Our worldwide service centers are staffed by experienced technicians, and use factory diagnostic methods, test fixtures, test and verification software, firmware upgrades, and service notes to ensure you get the most of your test budget.

All repair work includes any calibration and adjustments necessary to restore your equipment to published accuracy specifications, ensuring that all measurements can be trusted.

Calibration Options

Bird provides different calibration service levels depending on your requirements. Standard and accredited calibration services provide the traceability needed for regulatory requirements.

1 STANDARD CALIBRATION (ANSI/NCSL Z540.1)

This service provides a calibration certificate with a calibration date and a recommended calibration due date. A traceability statement is provided. As-Found and As-Left condition statements (i.e. in-tolerance or out-of-tolerance) are included.

2 STANDARD CALIBRATION (ANSI/NCSL Z540.1) WITH TEST REPORT

This service provides a calibration certificate with a calibration date and a recommended calibration due date. A traceability statement is provided. As-Found and As-Left measurement data and respective limits for each parameter tested during the calibration is provided. Measurement parameters not meeting the test specifications (out-of-tolerance) are identified and reported on the certificate. Product measurement uncertainties are available upon request. Additional charge will apply.

3 17025 ACCREDITED CALIBRATION WITH TEST REPORT

Instrumentation is calibrated in accordance with ISO/IEC 17025 within our approved scope of accreditation. Accredited calibrations provide a certificate of calibration with the accrediting body's logo on the document. This service provides a calibration certificate with a calibration date on the certificate and the recommended calibration due date. A traceability statement is provided. As-Found and as-Left measurement data and respective limits for each parameter tested during the calibration is provided. Measurement parameters not meeting the test specifications (out-of-tolerance) are identified and reported on the certificate. Product measurement uncertainties are available upon request. Additional charge will apply.



RF Training & Certification Services

Measurement challenges are increasing as standards and technologies constantly evolve. Build confidence and gain new skills to make accurate measurements through our Training and Certification services by Bird RF experts. E-Learning and Instructor-led courses enable you to build expertise in both technology and solutions. Instructor-led courses are customized to meet specific requirements and training can occur at your site.

E-Learning

- Available 24/7, free web-based courses enable you to learn at your pace.
- Go in-depth in specific topics, skip those you know, or repeat topics.
- Boost your measurement and technology knowledge.

Instructor-Led

- Customized courses to meet your specific requirements.
- Training can occur at your site using your equipment or ours.
- Certification available for select courses to demonstrate your mastery.

RF Technical Support

At Bird, we help companies address their toughest RF measurement, system, or application. Our dedicated technical applications engineers are a phone call or email away to help solve your problem. For self-service support, search our technical support center on BirdRF.com for FAQs, documentation, product videos and more.

Extended Warranties

Our factory warranty covers your equipment from failures and design flaws. Safeguard your investment and keep your Bird products running like new with an extension of the factory warranty.



Detect. Analyze. Defeat.

Validate performance on the bench, in the chamber, or on the range with X-Com Systems RF data recorders, RF playback and signal editing and analysis software solutions. Designed to record modern waveforms, the X-COM Systems products can meet recording needs from HF to millimeter wavelengths in mission-critical applications.

RF INTERFERENCE ANALYSIS ELECTRONIC WARFARE SURVEILLANCE SPECTRUM MANAGEMENT FORENSICS DESIGN VALIDATION



IQC91000A RF RECORD & PLAYBACK SYSTEM

With its 12 bit fidelity, the IQC91000A can continuously record 90 minutes of 1000 MHz wide waveforms to ensure designers capture transient and unexpected events.



IQC5000B SERIES RF RECORD & PLAYBACK SYSTEM

The IQC5000B series is the smallest, lightest, best-performing system available for the capture and replay of RF and microwave signals. Up to 255 MHz of record and playback bandwidth per channel, the IQC5000B can meet recording needs from HF to millimeter wavelengths in mission-critical applications.

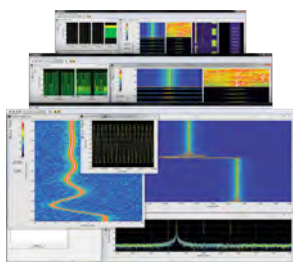

SPECTRO-X RF SIGNAL ANALYSIS TOOLKIT

Spectro-X is the essential signal extraction tool that enables users to sift through multi-terabytes of RF data recordings to quickly identify signals of interest. The fast, spectral search enables visualization and analysis, with high resolution, for system or test engineers.

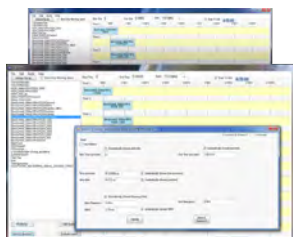

RF EDITOR RF SIGNAL EDITOR SOFTWARE TOOLKIT

RF Editor is a drag-and drop graphical editing tool that easily modifies I&Q signals of any length and creates entirely new ones. Modify and build signal waveforms in the time and frequency domains, make frequency domain signal modifications and move any signal or slice of spectrum anywhere among 10 time-domain tracks in the recording.

LEARN MORE ABOUT X-COM SYSTEMS OFF AIR SOLUTIONS
[birdrf.com/AboutUs/X-Com systems](http://birdrf.com/AboutUs/X-Com%20systems)



RF ANALYZERS

Measure with Confidence and Withstand Your Toughest Working Environments

Install and maintain wireless systems, perform in-depth troubleshooting, conduct routine maintenance and ensure your team's preparedness with Bird's portable RF analyzers. The rugged, hand-held equipment is not only used to maintain communication systems, but to also verify field performance with our Spectrum Analyzers, and identify and locate faults in the transmission system with our SiteHawk series of Cable and Antenna test equipment.



CABLE & ANTENNA ANALYZERS

[Page 14](#)



SPECTRUM ANALYZERS

[Page 15](#)



MASTER TEST KITS

[Page 16 - 17](#)



CABLE & ANTENNA KITS

[Page 18 - 19](#)



Cable & Antenna Analyzers

The SiteHawk series has been the preferred choice for installers, contractors and service providers for troubleshooting antenna and RF feedlines. Utilizing built-in measurement capabilities including precision return loss, VSWR, distance-to-fault and insertion loss, novice and expert technicians can perform testing for applications such as LMR, avionics, railway, cellular, and industrial communication systems to name a few.

1 WHAT DOES A CABLE AND ANTENNA ANALYZER DO?

- Assess the health of antenna and cable systems without the need for RF power
- Provides an operational baseline during antenna site commissioning
- Tests the overall integrity of the antenna system installation
- Verifies antenna system components meet manufacturer's design specification
- Pinpoints the location of the antenna systems faults prior to usage

2 WHO NEEDS A CABLE AND ANTENNA ANALYZER?

Anyone who is working on a cable and antenna RF system and needs to troubleshoot the common causes of Signal Reflections: Land Mobile Radio, Public Safety, Semiconductor, Wireless, Cellular and Broadcast, Military & Government, Medical, Aviation, Marine, Amateur Radio and Automotive.

Utilized for commissioning, maintenance and fault-finding of ground-to-air radios, airborne radios, repeaters, antennas, antenna combiners and transmission cables. Locate opens, shorts, improper crimps, bends, moisture, loose connectors, and defective antenna elements that lead to weak or intermittent RF operations. Common causes include:

- **Cable problems** - Open, shorted, dented, kinked, crimped, deformed, bullet hole, over tightened ground kit, over tightened clamp, water intrusion, improper bend radius
- **Connector problems** - Poor quality, improperly installed, improper center pin depth, corroded, water intrusion
- **Defective Antenna** - Improperly mounted, UV damage, damage from icing, lightning damaged, wrong frequency range

3 WHAT ARE THE KEY TYPES OF MEASUREMENTS?

FDR (Frequency Domain Reflectometry) measurement method results in a highly reliable assessment of the health of critical components in your system; ultimately providing a "heads-up" before a failure occurs. An FDR tests and verifies the antennas and cables in your RF system individually, or as a complete system.

VSWR is an abbreviation for Voltage Standing Wave Ratio and is a measurement of how well the components in a system match impedance. VSWR is expressed as a ratio without units.

Return Loss is the ratio of the maximum forward power in a transmission line to the power reflected back to the source. It is the power produced by a transmitter that is reflected back to the transmitter that could result in damage to the transmitter and does not add to the carrier's signal. Expressed in decibels, it is a measurement of how well systems components "match".

Insertion Loss is also known as cable loss and is the signal power lost within the feed line itself, including signal loss at joints, connectors, transitions, adapters, etc. Insertion loss takes place in one direction in a feed line and is the amount "lost" between the input end of a cable and the output connector of the same cable or system. Insertion loss is measured in dB.

Distance to Fault (DTF) is a measurement of how far from the test point a fault occurs. Instead of "hand-over-hand" checking of the feed line up a tower, the device will give a distance to the problem.



Spectrum Analyzers

With the expansion of wireless communications, spectrum analyzers like the Bird SignalHawk, are an essential part of the RF tool kit and are increasingly critical. Although traditionally stand-alone bench top test equipment, our handheld spectrum analyzers are ready for any field application.

1 WHAT IS A SPECTRUM ANALYZER?

Spectrum analyzers are designed for use in the installation and maintenance of Radio Frequency (RF) and wireless systems. They are important pieces of instrumentation to test radio frequency circuits and systems and provide effective insight into RF performance of a system, circuit, or module. This information provides detailed measurements about the spectrum of a signal. Signals of different frequencies and complex waveforms can be displayed to determine if they are falling within the required limits within the specified frequency.

2 HOW ARE SPECTRUM ANALYZERS USED?

When looking at the frequency spectrum of a signal you can see the following:

- The overall spectrum of a modulated signal which determines if the signal is too wide or narrow and causing interference
- Any unwanted or illegitimate signal that would cause interference to users on other frequencies when transmitted
- Determine if a signal is on the correct frequency and not in another band
- Power, frequencies, and phase noise in a signal
- Frequencies and the nature of a signal that may be causing an issue



3 SPECTRUM ANALYZER MEASUREMENTS

Bird's spectrum analyzers provide the user with quick predefined measurements for field use. This is very useful for field service applications where radio or wireless transmissions or other radio frequencies signals need to be monitored and the spectrum needs to be checked. Here are some key measurements you can perform with our analyzers.

Channel Power Measurement measures the Integration Bandwidth, the total power over a frequency range, concentrated on the center frequency of the sweep. It is useful for channelized (frequency-division multiplexed) signals. Results are shown in both total power in the channel (in dBm or Watts), and spectral density (dBm or W per Hz).

Adjacent Channel Power Ratio (ACPR) measures the relative power of frequency bands adjacent to a central channel. This is often used to identify power leakage from the center channel into the adjacent channels. The total power in the center (main) channel is displayed in dBm and the power in the adjacent channels (Lower and Upper) are given in dBc and dBm.

Phase Noise is signal fluctuations appearing as noise spreading out above and below the carrier. High Phase noise can reduce signal quality possibly increasing the communications link's error rate.

Occupied Bandwidth (OBW) measures the frequency band bandwidth that contains a specified percentage of the total power of the signal. It gives best results with single-peaked signals. Bandwidth measurement results are in Hz units.

N dB Measurement measures the frequency bandwidth at a user selected value in decibels below the signal peak. Bandwidth measurement results are in Hz units.

Field Strength measurement can be used to measure a single frequency (point) or a band of frequencies (the full span set on the SignalHawk), measurement results are in mV/m units. Field strength measurements are typically used to determine the amount of RF radiation emitted by electronic equipment.

FM Demodulation measurement may be used to demodulate a signal in the FM spectrum. When an FM signal of interest is tuned as the center frequency, the demodulated signal may be listened to through the SignalHawk's speakers or recorded (.wav) for playback later.

GNSS Signal Quality measurement is used to analyze Global Navigation Satellite System (GNSS (GPS, BeiDou)) signal quality through Carrier-to-Noise Ratio (CNR) Loss and Jammer-to-Noise Ratio (JNR).

Spectrum Masking allows limit lines to be placed on the display. Multiple limit lines may be added creating elaborate mask around signals of interest.

4 WHAT IS ANGLE OF ARRIVAL (AOA)?

AOA stands for "Angle of Arrival", also known as automatic direction finding and is an added software feature in the SH-60S-AOA. Using a technique called Triangulation, a signal strength sample is recorded in different locations, and the position is marked on a map, forming a triangle.

- AOA is the direction from which an RF Signal is received and is used to discover the location of an interfering signal, such as an unlicensed radio transmission, or other types of generators, producing RF signals disrupting lawful transmissions
- AOA measurement locates and senses the direction of the arriving transmitting signal, then calculates the relative orientation or angle
- Triangulation is when three or more measurements cross, identifying the location of the unknown signal

5 WHAT ARE SOME APPLICATIONS OF AOA?

When identifying situations that require AOA functionality, there are some common interfering sources:

- Faulty or poorly shielded electronic devices that allow energy to leak and interfere with other RF devices by creating inadvertent transmissions that broadcast in unknown locations, frequencies, and times.
- Incorrectly configured electronic devices
- Electronic devices that are not compliant with local regulations
- Jammers and deliberate interference





SiteHawk™ Cable & Antenna Analyzers

SK-4500-TC, SK-6000-TC, SK-9000-TC

Save critical time, components, and money by eliminating time swapping out components until you find and locate the issue. Discontinuities can be a real problem and cause significant reflections by damaged cables, loose or improperly installed connectors, and environmental factors. With Bird's SiteHawk™, find the exact location of the problem over a wide frequency range - from 1 MHz to 9000 MHz using Distance to Fault, return loss and cable loss measurements techniques.

PRODUCT FEATURES

- Locate RF cable, connector, and antenna problems at the source
- Test RF cables and antennas at the frequency of operation
- Fault location or DTF mode plots VSWR or Return Loss levels at each distance point along the cable and antenna system length
- Cable Loss function measures insertion loss of the cable system over a given frequency range
- Use FDR (Frequency Domain Reflectometry) measurement methods that will result in a highly reliable assessment of the health of critical components in your system; ultimately providing a "heads-up" before a failure occurs
- Single-port cable loss measurement

APPLICATIONS

- Cellular Networks 3G, 5G (2.4, 4.2 GHz & 600, 850 MHz), PCS/DCS, CDMA, GSM and LTE Protocols, Broadcast, Paging, Government, Tactical Military, Microwave, Public Safety, Trunking, TETRA, Network Coverage WLAN, WLL (802.11), Semiconductor calibration load/RF cable test, C-Band (4 to 8GHz) satellite communications and some X-Band radar frequency sub-bands with SK-9000-TC

COMPATIBLE WITH

- Basic, Wideband, and Statistical Power Sensors
- Bird RF Meter App

MEASUREMENT

Frequency Range	SK-4500-TC 1 MHz to 4500 MHz SK-6000-TC 1 MHz to 6000 MHz SK-9000-TC 1 MHz to 9000 MHz
Frequency Resolution	1 kHz
Output Power	-10 dBm, typical
Trace Noise Magnitude (IFBW 1kHz)	0.05 dB rms
Measurement Speed	1 ms/data point
Measurement Points	51 to 3201
Measure Bandwidth	100 Hz to 30 kHz
Temperature Stability	0.01 dB/°F (0.02 dB/°C)
Return Loss Measurement Range	0 dB to -60 dB
Resolution	0.01 dB
VSWR Measurement Range	1.0 to 65.0
Cable Loss Measurement Range	0 dB to 30 dB
DTF Range	0 to 5000 ft (0 to 1500 m)
Corrected Directivity	>38 dB
Maximum Input Voltage	50 V
Immunity to Interfering Signals	+13 dBm
Power Measurement	Yes

ACCURACY

Frequency Accuracy	±2.5 ppm @25 °C
Reflect Amplitude Accuracy	-10 dB to 0 dB: ±0.6 dB -20 dB to -10 dB: ±0.8 dB SK-4500-TC & SK-6000-TC -35 dB to -20 dB: ±3.0 dB
Reflect Amplitude Accuracy	-10 dB to 0 dB: ±0.6 dB -25 dB to -10 dB: ±1.5 dB SK-9000-TC -35 dB to -25 dB: ±4.0 dB

SYSTEM

Display	5.5 in, 1920 x 1080 p
Languages	English, Chinese, Spanish
Battery Type	Lithium-ion rechargeable
Battery Operating Time	10 hours typical
Battery Charge Time	5 hours typical
Storage Capacity	Thousands of trace and setups
Recommended Calibration Interval	3 years

CONNECTORS

Connector	USB Type-C, USB 3.0
Test Port Connector Impedance	N-type, Female 50 Ohms

ENVIRONMENTAL

Operating Temperature	14 °F to 131 °F (-10 °C to +55 °C)
Storage Temperature	-40 °F to 176 °F (-40 °C to +80 °C)
Battery Charging Temperature	32 °F to 95 °F (0 °C to +35 °C)

PHYSICAL

Size	7.7 in x 3.6 in x 2.4 in (195 mm x 90 mm x 60 mm)
Weight	1.98 lb (0.9 kg)

CERTIFICATIONS

CE	EMC: Standard EN 61326-1:2006
-----------	-------------------------------



SignalHawk™ Spectrum Analyzers

SH-60S-AOA, SH-60S-TC, SH-75S-AOA, SH-75S-TC

The SignalHawk™ family of handheld spectrum analyzers brings you the best in class functionality in a compact, portable, and affordable package. With an intuitive touchscreen user interface, you can unlock your potential and get the most out of your work. Our powerful spectrum analyzers help you detect, identify, and resolve interference issues quickly and accurately.

MEASUREMENT

Data Display	
SH-60S-AOA, SH-75S-AOA	Triangulated location on map
SH-60S-TC, SH-75S-TC	Waterfall
Frequency Range	
SH-60S-AOA, SH-60S-TC	9 kHz to 6 GHz
SH-75S-AOA, SH-75S-TC	9 kHz to 7.5 GHz
Aging	±1 ppm
Sweep Time	
SH-60S-AOA, SH-60S-TC	1.1 ms to 1600 s full span, 2.69 ms to 1600 s settable zero span
SH-75S-AOA, SH-75S-TC	1.2 ms to 1600 s full span, 3.99 ms to 1600 s settable zero span
Resolution Bandwidth	10 Hz to 5 MHz in 1, 2, 3, 5, 10 steps
Second Harmonic Distortion	1.6 GHz to 70 dBc
Third Order Intercept (TOI)	+15 dBm (-10 dBm tones, 1 MHz apart, preamp off, reference level -10 dBm)
P1dB	
SH-60S-AOA, SH-60S-TC	+5 dBm nominal
SH-75S-AOA, SH-75S-TC	0 dBm nominal
Phase Noise	
	-95 dBc/Hz, @10 kHz (typical -97 dBc/Hz)
	-115 dBc/Hz, @1 MHz (typical -116 dBc/Hz)
Measurement Range	DANL to +20 dBm
Input Attenuator Range	0 to 30 dB, 1 dB step

Input Attenuator Uncertainty	±0.6 dB
Display Average Noise Level (DANL)	
	Preamp Off: 1 GHz, -129 dBm/Hz (typical -132 dBm/Hz)
	Preamp +20 dB: 1 GHz, -149 dBm/Hz (typical -152 dBm/Hz)
	Preamp +40 dB: 1 GHz, -168 dBm/Hz (typical -169 dBm/Hz)
	(Input terminated, detector set to positive, trace average set to 1000, span set to 50 kHz, reference level of -100 dBm, all other settings auto-coupled, 23±5 °C normalized to 1 Hz RBW)
Residual Responses	
SH-60S-AOA, SH-60S-TC	-75 dBm
SH-75S-AOA, SH-75S-TC	-60 dBm
Max Safe Input Level	
	Preamp Off: +30 dBm
	Preamp +20 dB: 0 dBm
	Preamp +40 dB: -20 dBm
Reference Level Range	-140 dBm to +20 dBm, -190 dBm to +70 dBm (Ref level offset: ON)
RBW Switching Uncertainty	±0.3 dB
CONNECTORS	
RF In	N(F)
USB	USB type C
Power Interface	Slim tip, DC 20 V

PRODUCT FEATURES

- Leverages OpenStreetMap mapping technology from allowing users to triangulate the source
- Spectrogram/Waterfall display shows intermittent power levels at a glance
- View the spectrum with trace display, spectrogram display, or both
- More than 2x faster sweep times than the competition
- High-resolution, full-color display for indoor/outdoor, and multi-screen viewing
- Rugged and weather resistant

PREDEFINED MEASUREMENTS

- Channel Power
- Adjacent Channel Power Ratio (ACPR)
- Phase Noise
- N dB Down Bandwidth
- Occupied Bandwidth (OBW)
- Field Strength
- FM Demodulation
- CNR Loss (GNSS Signal Quality)
- Spectrum Masking and Limit Lines
- Gate Scanning with SH-75S series

COMPATIBLE WITH

- Basic, Wideband, and Statistical Power Sensors
- Bird RF Meter App
- ANT Series, Field Strength Antennas

ACCURACY

Frequency Span Accuracy	±1%
RBW Accuracy	≥1 MHz, ±10%, <1 MHz, ±2%
Amplitude Accuracy	±1.5 dB (ATT set to 0 dB, input signal -5 to -30 dBm, detector set to positive, sensitivity set to low, RBW auto-coupled, all other settings auto-coupled, 23±5 °C. Half hour warm-up required.)
Reference Level Accuracy	≥-60 dBm, ±0.8 dB

SYSTEM

Display	5.5 in, 1280 *720p
OS	Android
Languages	English, Chinese
Battery Type	Lithium-ion rechargeable
Battery Operating Time	5 hours typical
Battery Charge Time	6 hours typical

ENVIRONMENTAL

Operating Temp	0 °C to 50 °C
Storage Temp	-20 °C to 70 °C

PHYSICAL

Size	7.8 in x 3.7 in x 2.4 in (197 mm x 93 mm x 61 mm)
Weight	1.98 lb (0.9 kg)

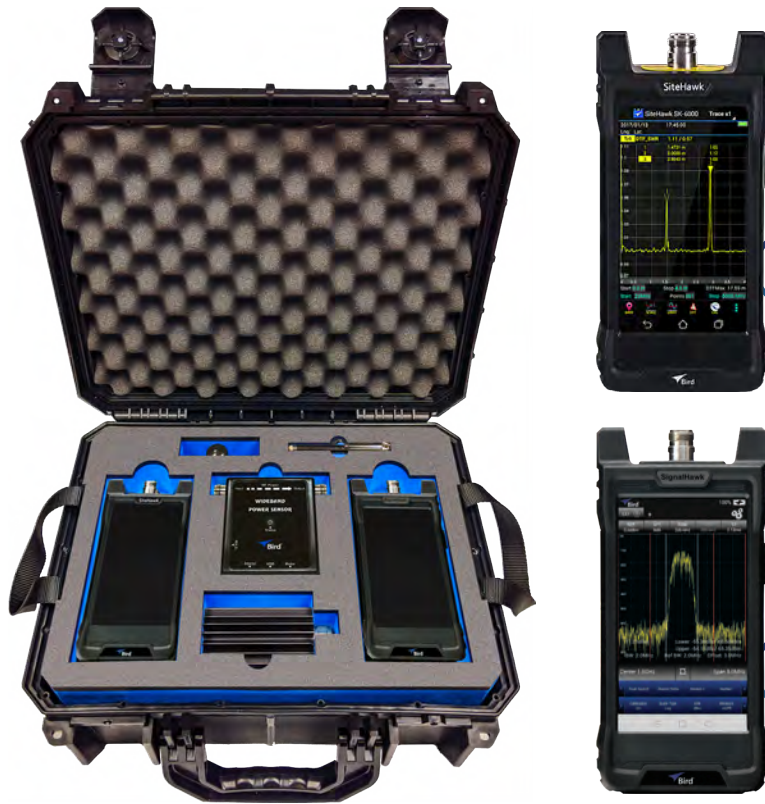

CABLE & ANTENNA ANALYZER FEATURES

- Wide frequency range from 1 MHz to 6 GHz
- Test RF cables and antennas at the frequency of operation
- Distance to Fault, return loss, cable loss
- Frequency domain reflectometry
- RF Power Measurement Support with RF Meter App and Bird's USB Wideband Power Sensors through OTG USB communication port

SPECTRUM ANALYZER FEATURES

- Wide frequency range between 9 kHz to 6 GHz providing real-time spectrum monitoring and analysis of RF frequency circuits
- Predefined Measurements: Channel Power, ACPR, OBW, Phase Noise, N dB Down Bandwidth, Field Strength, FM Demodulation and more
- View the spectrum with trace display, spectrogram display, or both

KITS INCLUDE

Master RF Test Kits

SK-SH-KIT

Bird's Master RF Test Kit combines the best in Bird test & measurement equipment for field technicians and engineers to install, analyze, troubleshoot, and maintain both coaxial and antenna systems

This Master RF Test kit provides all the necessary equipment needed including the Bird SiteHawk™ Cable and Antenna Analyzer and SignalHawk™ Spectrum Analyzer, wideband power sensor, calibration combo, adapter kit, termination/load and cables all housed in a hard shell, organized case.

Bird's rugged and reliable test & measurement equipment provides all the coverage you need for any cable & antenna installation or maintenance as well as interference analysis of cellular systems, land mobile radio systems and Wi-Fi.

This kit is ideal for wireless service providers, contractors, military, aerospace and defense, and public safety applications.



SK-6000-TC
CABLE & ANTENNA
ANALYZER

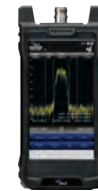

SH-60S-TC
SPECTRUM
ANALYZER



5017D-AV
POWER SENSOR



SK-CAL-MN-C6
CALIBRATION
COMBO



FH-AV-CC
HARD CARRYING
CASE



4240-401
ADAPTER KIT

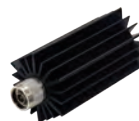

25-T-MN
TERMINATION/LOAD
RESISTOR

OPTIONAL KIT

- SK-SH-KITA is a Master RF Kit with SH-60S-AOA substituted for interference hunting.



SiteHawk™ Test Kits

7003A001 SERIES

Bird's SiteHawk Test Kits provide all the necessary equipment needed to perform precise power measurements to quickly identify faulty antennas, cables, and connectors in order to resolve issues and return radio systems to service. Easily select your kit by frequency range and power range with a variety of combinations of sensors and analyzers for expanded capabilities.

Kits include either a Bird SiteHawk SK-4500-TC or SK-6000-TC Cable and Antenna Analyzer covering up to 6 GHz, calibration combo, adapter kit, termination/load, and cables all housed in a hard shell, organized case. Avoid the downtime and expense of trial-and-error component swapping to find and fix issues with the Bird® SiteHawk Test Kit.

POWER SENSOR SELECTION GUIDE

MODEL	SENSOR	FREQUENCY RANGE	POWER RANGE
7003A001-5	None	N/A	N/A
7003A001-6	7020-1-010101	350 MHz to 4.0 GHz	150 mW to 150 W
7003A001-7	7020-1-030301*	25 MHz to 1.0 GHz	500 mW to 500 W
7003A001-8	5017D*	25 MHz to 1.0 GHz	500 mW to 500 W 1000 W Peak
7003A001-9	7022-1-020201	350 MHz to 4.2 GHz	150 mW to 150 W
7003A001-19	5019D	25 MHz to 1.0 GHz	100 mW to 100 W 260 W Peak

*Derate maximum average power rating from 500 W at 300 MHz to 100 W at 1 GHz using a straight line on a log-log scale.

PRODUCT FEATURES

- Determine if there is a problem with your cable and antenna system using the Measure Match function
- Locate the problem source with the Use Distance to Fault measurement
- Multiple models available utilizing Bird power sensors with varying frequency and power ranges in order to select the model best suited to the application

KITS INCLUDE



SK-4500-TC or
SK-6000-TC
CABLE & ANTENNA
ANALYZER



SK-CAL-MN-C6
CALIBRATION
COMBO



4240-401
ADAPTER KIT

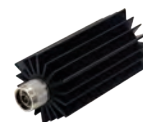

25-T-MN
TERMINATION/LOAD
RESISTOR



5000-035
HARD CARRYING
CASE



5A2970-16-120B
10' RG142 CABLE

SITEHAWK OPTION

- SK-6000-TC can be substituted for SK-4500-TC by adding -6 to the part number, e.g. 7003A001-5-6.



FlightHawk™ Aviation Cable & Antenna Analyzer Kits

FH-AV-KIT, FH-AV-BASIC

The basic kit, FH-AV-BASIC, provides all of the essential RF measurement capabilities required for installing and maintaining aircraft antenna systems. Ideal for identifying failing RF cables, connectors, antennas, and more.

The master kit, FH-AV-KIT, is a comprehensive solution that adds RF power measurement capabilities. Included are Bird's wideband power sensor, a 25 W compact load, and all necessary adapters and cables.

MEASUREMENT

Frequency Range	1 MHz to 6000 MHz
Frequency Resolution	1 kHz
Output Power	-10 dBm, typical
Trace Noise Magnitude (IFBW 1kHz)	0.05 dB rms
Measurement Speed	1 ms/data point
Measurement Points	51 to 3201
Measure Bandwidth	100 Hz to 30 kHz
Temperature Stability	0.01 dB/°F (0.02 dB/°C)
Return Loss Measurement Range	0 dB to -60 dB
Resolution	0.01 dB
VSWR Measurement Range	1.0 to 65.0
Cable Loss Measurement Range	0 dB to 30 dB
DTF Range	0 to 5000 ft (0 to 1500 m)
Corrected Directivity	>38 dB
Maximum Input Voltage	50 V
Immunity to Interfering Signals	+13 dBm
Power Measurement	Yes

ACCURACY

Frequency Accuracy	±2.5 ppm @25 °C
Reflect Amplitude Accuracy	<-10 dB to 0 dB: ±0.6 dB <-20 dB to -10 dB: ±0.8 dB -35 dB to -20 dB: ±3.0 dB

SYSTEM

Display	5.5 in, 720p
Languages	English, Chinese, Spanish
Battery Type	Lithium-ion rechargeable
Battery Operating Time	10 hours typical
Battery Charge Time	5 hours typical
Storage Capacity	Thousands of trace and setups
Recommended Calibration Interval	2 years

Compatible With For a complete list of compatible sensors see Bird's RF Meter page <http://bit.ly/rfmeterrapp2>

CONNECTORS

Connector	USB Type-C, USB 3.0
Test Port Connector Impedance	N-type, Female 50 Ohms

PRODUCT FEATURES

- Locate opens, shorts, improper crimps, bends, moisture, loose connectors, and defective antenna elements that lead to weak or intermittent RF operations.
- Utilize the FDR technology to perform a VSWR test by transmitting a continuous RF sweep of the cables & antenna at their operating frequencies.
- Easy to use handheld tester, enabling the user to configure a Go/No-Go test by using the Pass/Fail, Limit Line, and Marker tools. This option can be used for a Measure/Match or Distance to Fault sweep.
- Identifies issues easily from the equipment rack, eliminating the need to disassemble the airplane to test the RF system.

THE MASTER FH-AV-KIT INCLUDES



FLIGHTHAWK™



5017D-AV POWER SENSOR



SK-CAL-MN-C6 CALIBRATION COMBO



FH-AV-CC HARD CARRYING CASE



4240-401 ADAPTER KIT



25-T-MN TERMINATION/LOAD RESISTOR

THE FH-AV-BASIC INCLUDES



FLIGHTHAWK™



FH-AV-CC HARD CARRYING CASE

PHYSICAL

Size	7.7 in x 3.6 in x 2.4 in (195 mm x 90 mm x 60 mm)
Weight	1.98 lb (0.9 kg)

CERTIFICATIONS

CE	EMC: Standard EN 61326-1:2006
----	-------------------------------



RailHawk™ Railway Cable & Antenna Analyzer Kit

RH-RR-KIT

Bird's new Railway RF Cable & Antenna Analyzer solution provides a comprehensive kit that allows technicians to maintain high quality service networks in the railway industry. Based on the need for redundant communications, Bird's Cable & Antenna Analyzer increases reliability and assures maintainability for communication protocols targeted in railway space.

MEASUREMENT

Frequency Range	1 MHz to 6000 MHz
Frequency Resolution	1 kHz
Output Power	-10 dBm, typical
Trace Noise Magnitude (IFBW 1kHz)	0.05 dB rms
Measurement Speed	1 ms/data point
Measurement Points	51 to 3201
Measure Bandwidth	100 Hz to 30 kHz
Temperature Stability	0.01 dB/°F (0.02 dB/°C)
Return Loss Measurement Range	0 dB to -60 dB
Resolution	0.01 dB
VSWR Measurement Range	1.0 to 65.0
Cable Loss Measurement Range	0 dB to 30 dB
DTF Range	0 to 5000 ft (0 to 1500 m)
Corrected Directivity	>38 dB
Maximum Input Voltage	50 V
Immunity to Interfering Signals	+13 dBm
Power Measurement	Yes

ACCURACY

Frequency Accuracy	±2.5 ppm @25 °C
Reflect Amplitude Accuracy	<-10 dB to 0 dB: ±0.6 dB <-20 dB to -10 dB: ±0.8 dB -35 dB to -20 dB: ±3.0 dB
SYSTEM	
Display	5.5 in, 720p
OS	Android
Languages	English, Chinese, Spanish
Battery Type	Lithium-ion rechargeable
Battery Operating Time	10 hours typical
Battery Charge Time	5 hours typical
Storage Capacity	Thousands of trace and setups
Recommended Calibration Interval	2 years
Compatible With	Bird's RF Meter App utilizing RF compatible sensors 501X, 7020, 7022 Series

CONNECTORS

Connector	USB Type-C, USB 3.0
Test Port Connector Impedance	N-type, Female 50 Ohms

ENVIRONMENTAL

Operating Temperature	14 °F to 131 °F (-10 °C to 55 °C)
Storage Temperature	-40 °F to 176 °F (-40 °C to 80 °C)
Battery Charging Temperature	32 °F to 95 °F (0 °C to 35 °C)

PHYSICAL

Size	7.7 in x 3.6 in x 2.4 in (195 mm x 90 mm x 60 mm)
Weight	1.98 lb (0.9 kg)

CERTIFICATIONS

CE	EMC: Standard EN 61326-1:2006
----	-------------------------------

PRODUCT FEATURES

- Test RF cables & antennas at the frequency of operation, not at DC where problems are masked.
- Locate RF cable, connector & antenna problems at the source.
- FDR (Frequency Domain Reflectometry) pinpoints faults at the frequency of operation, unlike other measurement techniques which can mask pending failures of critical system components.
- Distance to Fault (DTF) mode can plot VSWR or Return Loss levels at each distance point along the cable and antenna system length.
- Cable Loss function measures insertion loss of the cable system over a given frequency range.
- OTG USB communication port for connection to Bird power sensors, storage devices and charging.

KIT INCLUDES



RAILHAWK™

7020-1-010101
POWER SENSORSK-CAL-MN-C6
CALIBRATION COMBOFH-AV-CC
HARD CARRYING
CASE4240-550, 4240-401
ADAPTER KITS25-T-MN
TERMINATION/LOAD
RESISTOR



PRECISION RF PRODUCTS

Minimize Process Variability with Precision RF Measurement Tools

Bird Laboratory Grade RF Products range from our 4020 Series RF power sensors capable of 3% accuracy to the advanced 7037 Series pulse power sensors capable of 0.5% accuracy. These highly accurate sensors have also been integrated into turnkey calibration carts that comprise all the components required to measure, display, and dissipate power from RF delivery systems. Even more sophisticated systems, the BDS has been developed to not only measure voltage and current but also the phase relationships between them to enable a higher degree of insight into modern, complex semiconductor processes.



POWER METERS

Page 23



RF POWER SENSORS

Page 24 - 29



DIAGNOSTIC SYSTEMS

Page 30 - 31



CALIBRATION CARTS

Page 32 - 36



RF CALIBRATION KIT

Page 37



Improving Process Consistency with Precision RF Power Measurement

Technological innovation continues to intensify with semiconductor designs that incorporate smaller features and higher densities. To fabricate these latest designs, an advanced level of process control is paramount. For processes that rely on plasma generation, RF power consistency is essential for optimizing performance, maximizing yields, and minimizing downtime.

Bird's Precision RF Products enable you to address RF measurement challenges with the highest precision instruments in the market. Our power sensor solutions that measure both continuous wave and pulsed signals future proof your RF measurement needs. In addition, the Bird Diagnostic System provides detailed insight with measurements made in close proximity to the plasma chamber. Further, calibration carts with built in sensor, meter and load simplifies the task of verifying RF performance across a site's entire fleet of tools.

1 WHAT IS THE DIFFERENCE BETWEEN POWER MEASUREMENTS AND VOLTAGE, CURRENT & PHASE MEASUREMENTS?

Power Measurements - Power measurements are made using directional couplers that sample the RF signal present in the delivery path. However, due to a coupler's finite directivity, the system's characteristic impedance needs to be maintained close to 50 Ohms. Within this part of the RF delivery system, Bird's Power Sensors have been the industry standard for precision power measurements. These sensors are easy to use with excellent accuracy and repeatability.

Voltage, Current & Phase Measurements - The impedance of a plasma chamber is complex and changes with each step of a process recipe. Measurements made with a power sensor in this impedance space will result in directivity errors. In this situation, the RF Signal can be measured by its voltage and current. In addition, the phase relationship between the voltage and current measurements can also be determined to provide a complete description of the signal. The Bird Diagnostic System provides the ideal RF measurement solution for applications such as delivered power measurement, end-point detection, and transient detection.

2 WHY IS CALIBRATION IMPORTANT?

Calibration that is traceable to the National Institute of Standards and Technology (NIST) is crucial in ensuring sensor accuracy and consistency across multiple measurement devices. This consistency enables an organization to develop a process at one location and then to proliferate it to multiple production lines across the globe.

Bird has a long history of calorimetry, which is the most accurate method of measuring RF power. Over the past decades, Bird has continued to refine this technology to achieve better and better accuracy. The proprietary calorimeters developed by Bird are NIST traceable and are many times more accurate than the products that are calibrated through them. Our 1% and 0.5% power sensors would not be a success without the technological advances Bird has made to calorimetry.

3 WHAT ARE APPLICATIONS FOR AN RF POWER SENSOR?

- Calibrate RF generators to ensure setpoint accuracy
- Fingerprint systems to identify performance drifts and to predict failures
- Troubleshoot RF delivery path to root cause performance issues
- Capture critical-to-quality parameters for site-to-site comparisons

4 WHAT ARE APPLICATIONS FOR THE BIRD DIAGNOSTIC SYSTEM?

- Improve process control with recipe step end-point detection
- Identify excursions such as arcing within a plasma chamber
- Monitor performance for determining maintenance needs
- Compare chamber-to-chamber performance differences

Precision RF Products Selection Guide

POWER SENSOR SELECTION GUIDE

SERIES	ACCURACY	ACCURACY RANGE	SIGNAL TYPE	FREQUENCY RANGE	MEASUREMENT
7037	0.5%	At calibration frequencies, across specified power range	Multi-level pulse & CW	0.4 MHz to 60 MHz	Forward Average Power, Forward Pulse Power, Reflected Average Power, Match
7027	1%	At calibration frequencies, across specified power range	Multi-level pulse & CW	0.4 MHz to 60 MHz	Forward Average Power, Forward Pulse Power, Reflected Average Power, Match
4027A	1%	At calibration frequencies, at 1700 W	CW	0.25 MHz to 170 MHz	Forward Average Power, Reflected Average Power, Match
4027F	1%	At calibration frequencies, at 1700 W	CW (includes sensor filters for harmonics)	1.8 MHz to 63 MHz	Forward Average Power, Reflected Average Power, Match
4028	2%	At calibration frequencies, at 1700 W	CW	0.25 MHz to 30 MHz	Forward Average Power, Reflected Average Power, Match
4020	3%	Across specified frequency and power ranges	CW	0.1 MHz to 3 GHz	Forward Average Power, Reflected Average Power, Match

DIAGNOSTIC SYSTEM SELECTION GUIDE

SERIES	VOLTAGE & CURRENT ACCURACY	CALIBRATION	SIGNAL TYPE	FREQUENCY RANGE	MEASUREMENT
BDS2-Locked	Up to 1%	As a system	Multi-level pulse & CW	0.307 MHz to 250 MHz	V, I, Phase, Power
BDS2-Unlocked	Up to 2%	Individual components	Multi-level pulse & CW	0.307 MHz to 250 MHz	V, I, Phase, Power

CALIBRATION CART SELECTION GUIDE

SERIES	ACCURACY	# OF SENSORS	FREQUENCY	POWER LEVEL
SCC7	Up to 1% or 3%, depending on sensor	1	Up to 170 MHz	Up to 1 kW, 2.5 kW, 5 kW or 10 kW, depending on load and sensor
SCC8	Up to 2%, depending on sensor	1	Up to 30 MHz	Up to 25 kW, depending on sensor
MSCC7	Up to 1% or 3%, depending on sensor	2 (only one can be powered up at a time)	Up to 30 MHz	Up to 5 kW or 10 kW, depending on load and sensors

POWER METER SELECTION GUIDE

SERIES	# OF SENSORS	# OF SENSOR CHANNELS	INTERFACES
4421A-10-00-0	Single 402x Sensor	1	None
4421A-20-00-0	Dual 402x Sensors	2	None
4421A-10-11-0	Single 402x Sensor	1	RS-232, LAN
4421A-20-11-0	Dual 402x Sensors	2	RS-232, LAN
4421A-12-11-1	Single 402x Sensor Dual 702x/703x Sensors**	2	RS-232, LAN

** 702x/703x Sensors are currently supported for Average Power measurements. Pulse Power parameter measurements will be added with a free, in-field installable software update in 2023.



Multifunction Power Meters

MODEL 4421A

The Model 4421A is a Multifunction Power Meter to be used in combination with Bird's Precision Power Sensors to display RF power readings with up to .5% accuracy. This intuitive display unit clearly identifies the Forward and Reflected power measurements within the RF path. In addition, return loss readings can also shown to provide additional insight into the RF system being monitored.

PRODUCT FEATURES

- Compatible with the full line of Bird's 402x-Series power sensors
- Automatic sensor detection for seamless integration
- Large 9.7 in full color LCD touchscreen display for easy readability
- Dual sensor option expands measurement capabilities
- Compact, lightweight, and portable design enhances functionality

FUNCTIONS

- Forward Power in W or dBm
- Reflected Power in W or dBm
- Return Loss in VSWR, RL, or Reflection Coefficient
- Graph of Power in W Over Time



	4421A-10-00-0	4421A-20-00-0	4421A-10-11-0	4421A-20-11-0	4421A-12-11-1
# of Sensors	Single 402x Sensor	Dual 402x Sensors	Single 402x Sensor	Dual 402x Sensors	Single 402x Sensor Dual 702x/703x Sensors**
# of Sensor Channels	1	2	1	2	2
Interface	None	None	RS-232, LAN	RS-232, LAN	RS-232, LAN
# of Latch-n-Lock Cables included	1	2	1	2	1

** 702x/703x Sensors are currently supported for Average Power measurements. Pulse Power parameter measurements will be added with a free, in-field installable software update in 2023.

MEASUREMENT

Compatible Bird Sensors	4021, 4022, 4023, 4024, 4025, 4027 Series, 4028 Series, 702x, 703x
Frequency Range	Sensor dependent
Power Range	Sensor dependent
Sensor Channels	Model dependent, 1 or 2
VSWR Display	1.0 to 199.9
Return Loss Display	0 to 40 dB

CONNECTORS

Interfaces	Model dependent: RS-232, RJ-45
------------	--------------------------------

SYSTEM

Display	9.7 in TFT full color LCD with touch screen
AC Power	100-240 VAC, 50/60 Hz, 30 W
Fuse Rating	1A, IEC (5 x 20 mm), time-delay
Battery Type	Internal, rechargeable
Battery Operating Time	Up to 7 hours
Battery Charger	Built-in. Approximately 4 hours to fully recharge.

PHYSICAL

Size	10.6 in x 9.7 in x 3.6 in (269 mm x 246 mm x 91 mm)
Weight	Less than 5 lb

ENVIRONMENTAL

Operating Temperature	0 °C to 40 °C
Storage Temperature ¹	10 °C to 50 °C < 1 month 10 °C to 35 °C < 6 months 10 °C to 25 °C > 6 months
Humidity	95% max, non-condensing
Altitude	4,600 m max

CERTIFICATIONS

CE	CE Compliant
Shock and Vibration	MIL-PRF-28800F Class 4 Compliant

¹Storage temperature limited by battery specification. Storage outside this range may degrade battery performance. For best performance, a full recharge is recommended every 6 months or if stored below 0 °C.



PRODUCT FEATURES

- Time domain display
- Gated power measurements with up to four sets of gates available
- Capable of $\pm 0.5\%$ power measurement accuracy
- NIST traceable calibration
- Measure pulse state widths down to 1 μ s (sensor dependent)
- Measure pulse rep. rates from 10 Hz up to 100 kHz
- Harmonic filtering
- External sync input
- RF Interlock (optional)
- Automate with SCPI command set

BENEFITS

- Enhances the set point accuracy of the RF sources
- Optimizes source-to-source consistency across the fleet
- Delivers power measurements to 0.5% accuracy across its dynamic range
- Simplifies measurements of multilevel pulses
- Streamlines data collection efforts via UI or API

Precision RF Power Sensors

7037 SERIES

0.5% ACCURACY

Bird's® 7037 Series RF Power Sensor is capable of a stunning 0.5% accuracy for measurements of the CW and pulsed signals. This precision sensor is an invaluable tool for development and production engineers who require the most precise accuracy in lab and semiconductor fab environments. Calibration is NIST traceable.

7037	FREQUENCY RANGE	POWER RANGE	PULSE REP RATE
7037-1-524001-xyxy	0.4 MHz $\pm 10\%$	25 W to 25 kW	10 Hz to 11.25 kHz
7037-1-544301-xyxy	2 MHz $\pm 10\%$	10 W to 10 kW	10 Hz to 50 kHz
7037-1-595701-xyxy	13.56 MHz $\pm 5\%$	100 W to 10 kW	100 Hz to 100 kHz
7037-1-605801-xyxy	27.12 MHz $\pm 5\%$	60 W to 6 kW	100 Hz to 100 kHz
7037-1-616101-xyxy	40.68 MHz $\pm 5\%$	75 W to 7.5 kW	100 Hz to 100 kHz
7037-1-625801-xyxy	60 MHz $\pm 5\%$	60 W to 6 kW	100 Hz to 100 kHz

Connector Options (xyxy): 7/16 DIN, N, HN, LC, QRM and others that are available on request

MEASUREMENT

Measurement Type	CW & Multi-State Pulsed RF Power
Impedance	50 Ohms nominal
7037 Series Power Measurement Accuracy	.5% at calibrated frequencies 1.5% at all other frequencies within sensor bandwidth
VSWR Range	1.0:1 to 2.0:1
Insertion Loss	<0.05 dB max
Insertion VSWR	1.05 max
Directivity	28 dB min

CONNECTORS

RF Connectors	QC 7/16 DIN, N, HN, LC, QRM and others that are available on request
---------------	--

SYSTEM

Recommended Calibration Interval	6 months
Interface	USB 2.0
Power Supply	Via supplied USB Cable
External Sync Input	TTL High, 2-5 V TTL Low, 0-0.85 V
Compatible With	VPM3

ENVIRONMENTAL

Operating Temperature	15 °C to 35 °C (59 °F to 95 °F)
Storage Temperature	-20 °C to 70 °C (-4 °F to 158 °F)
Humidity	95% max (non-condensing)
Altitude	15,000 ft max (4,500 m max)

PHYSICAL

Size	6.0 in x 3.7 in x 1.9 in (155 mm x 95 mm x 50 mm) Not including QC connectors
Weight	Less than 3 lb

CERTIFICATIONS

Mechanical Shock and Vibration	Designed to meet MIL-PRF-28800F class 3
EMC	EMC Directive (2004/108/EC) European Standard: EN 61326 Electrical Equipment for measurement, control and laboratory use EMC Requirements: Test Spec (for radiated immunity) EN 61000-4-3 - Testing and measurement techniques - 10V/meter
CE	CE Compliant
RoHS	Compliant



Precision RF Power Sensors

7027 SERIES

1% ACCURACY

Bird's® 7027 Series RF Power Sensors for precision semiconductor applications bring reliable and traceable accuracy to development and production engineers in lab and semiconductor fab environments. At calibrated frequencies, this sensor is capable of 1% accuracy for measurements of the CW and pulsed signals. Calibration is NIST traceable.

PRODUCT FEATURES

- Time domain display
- Gated power measurements with up to four sets of gates available
- Capable of $\pm 1\%$ power measurement accuracy
- NIST traceable calibration
- Measure pulse state widths down to 1 μ s (sensor dependent)
- Measure pulse rep. rates from 10 Hz up to 100 kHz
- Harmonic filtering
- External sync input
- RF Interlock (optional)
- Automate with SCPI command set

BENEFITS

- Enhances the set point accuracy of the RF sources
- Optimizes source-to-source consistency across the fleet
- Delivers power measurements to 1% accuracy across its dynamic range
- Simplifies measurements of multilevel pulses
- Streamlines data collection efforts via UI or API

7027	FREQUENCY RANGE	POWER RANGE	PULSE REP RATE
7027-1-524001-xyxy	0.4 MHz $\pm 10\%$	25 W to 25 kW	10 Hz to 11.25 kHz
7027-1-544601-xyxy	2 MHz $\pm 10\%$	10 W to 5 kW	10 Hz to 50 kHz
7027-1-594301-xyxy	13.56 MHz $\pm 5\%$	10 W to 10 kW	100 Hz to 100 kHz
7027-1-604801-xyxy	27.12 MHz $\pm 5\%$	10 W to 3 kW	100 Hz to 100 kHz
7027-1-615501-xyxy	40.68 MHz $\pm 5\%$	75 W to 7.5 kW	100 Hz to 100 kHz
7027-1-624901-xyxy	60 MHz $\pm 5\%$	30 W to 6 kW	100 Hz to 100 kHz

Connector Options (xyxy): 7/16 DIN, N, HN, LC, QRM and others that are available on request

MEASUREMENT

Measurement Type	CW & Multi-State Pulsed RF Power
Impedance	50 Ohms nominal
7027 Series Power Measurement Accuracy	1% at calibrated frequencies 2% at all other frequencies within sensor bandwidth
VSWR Range	1.0:1 to 2.0:1
Insertion Loss	<0.05 dB max
Insertion VSWR	1.05 max
Directivity	28 dB min

CONNECTORS

RF Connectors	QC 7/16 DIN, N, HN, LC, QRM and others that are available on request
----------------------	--

SYSTEM

Recommended Calibration Interval	6 months
Interface	USB 2.0
Power Supply	Via supplied USB Cable
External Sync Input	TTL High, 2-5 V TTL Low, 0-0.85 V
Compatible With	VPM3

ENVIRONMENTAL

Operating Temperature	15 °C to 35 °C (59 °F to 95 °F)
Storage Temperature	-20 °C to 70 °C (-4 °F to 158 °F)
Humidity	95% max (non-condensing)
Altitude	15,000 ft max (4,500 m max)

PHYSICAL

Size	6.0 in x 3.7 in x 1.9 in (155 mm x 95 mm x 50 mm) Not including QC connectors
Weight	Less than 3 lb

CERTIFICATIONS

Mechanical Shock and Vibration	Designed to meet MIL-PRF-28800F class 3
EMC	EMC Directive (2004/108/EC) European Standard: EN 61326 - Electrical Equipment for measurement, control and laboratory use EMC Requirements Test Spec (for radiated immunity) EN 61000-4-3 - Testing and measurement techniques - 10V/meter
CE	CE Compliant
RoHS	Compliant



Precision Directional RF Power Sensors

4027A SERIES

±1% ACCURACY

The 4027A Series Power Sensors from Bird bring superb accuracy and ease of use together for the laboratory engineer. In semiconductor processing and other precision process applications where accuracy is critical, these sensors are capable of 1% accuracy at the calibrated frequency and power level. Calibration is traceable to the National Institute of Standards and Technology (NIST), providing additional confidence in sensor measurement.

4027A	FREQUENCY RANGE	POWER RANGE
4027A12M	10 to 15 MHz	300 mW to 1 kW
4027A250K	250 to 400 kHz	3 W to 10 kW
4027A400K	400 to 550 kHz	3 W to 10 kW
4027A800K	800 to 950 kHz	3 W to 10 kW
4027A2M	1.5 to 2.5 MHz	3 W to 10 kW
4027A4M	3 to 5 MHz	3 W to 10 kW

	FREQUENCY RANGE	POWER RANGE
4027A10M	10 to 15 MHz	3 W to 10 kW
4027A25M	25 to 30 MHz	3 W to 9 kW
4027A35M	35 to 45 MHz	3 W to 7.5 kW
4027A60M	45 to 65 MHz	3 W to 6 kW
4027A100M	95 to 105 MHz	3 W to 4 kW
4027A150M	150 to 170 MHz	3.75W to 3.75 kW

PRODUCT FEATURES

- 1% accuracy at specified frequencies and power levels
- Models do not need to be field calibrated before use and only need to be calibrated once every six months
- Plug and Play with the 4421A Multifunction Meter
- Dozens of connector options available
- Calibration traceable to the National Institute of Standards and Technology

FOR USE WITH

- 4421A Multifunction Power Meters
- SCC7 Calibration Cart
- MSCC7 Calibration Cart

BENEFITS

- Enhances the set point accuracy of the CW RF source
- Optimizes source-to-source consistency across the fleet
- Delivers forward and reflected power measurements to 1% accuracy
- Reduces ambiguity with straightforward operation and measurement display

MEASUREMENT

Accuracy	±1% at calibration frequencies and power levels ±2% at other frequency and power levels - add 2% to uncertainty outside 25 ±10 °C
Uniformity	2% maximum unit to unit, at calibration frequency and power levels
Speed	2 readings per second
Harmonic Content	-50 dBc max
VSWR Range	1.00 to 2.00
Directivity	28 dB
Insertion Loss	<0.05 dB

Calibration Power Level	1000 W units: 700 W Other units: 1700 W
Maximum Power	Sensor Frequency Dependent

CONNECTORS

RF Connectors	Customer specified
----------------------	--------------------

SYSTEM

Recommended Calibration Interval	6 month. Performance before and performance after data supplied with recalibrations
Power Supply	External DC, 12VDC, supplied from Bird 4421A Power Meter

ENVIRONMENTAL

Operating Temperature	0 °C to 50 °C (32 °F to 122 °F)
Storage Temperature	-20 °C to 70 °C (-4 °F to 158 °F)
Humidity	95% max (non-condensing)
Altitude	Up to 10,000 ft (3,048m)

PHYSICAL

Size	5.2 in x 2.5 in x 3.25 in (137 mm x 64 mm x 83 mm)
Weight	1 lb 13 oz (0.8 kg)

CERTIFICATIONS

EMC	Designed to carry CE mark
------------	---------------------------



Precision Filtered RF Power Sensors

4027F SERIES

±1% ACCURACY

The Bird 4027F Series RF Power Sensors are designed specifically for use in semiconductor processing and other precision process applications where the effects of amplitude modulation and harmonics need to be eliminated from the measurement. Because accuracy is critical, these sensors are capable of ±1% accuracy at the calibrated frequency and power level. Calibration is traceable to the National Institute of Standards and Technology (NIST), providing additional confidence in sensor measurement.

	4027F2M	4027F10M	4027F60M
Frequency Range	1.8 to 2.2 MHz	12 to 15 MHz	57 to 63 MHz
Power Range	100 W to 10 kW	100W to 10 kW	100W to 6 kW
Calibration Frequency, Type	1.8, 2.0, 2.17 MHz	12.0, 12.5, 13.56, 14.0, 15.0 MHz	57.0, 58.5, 60.0, 61.5, 63 MHz
Harmonic Rejection, Min	26 dB@3.6 MHz to 3.8 MHz, 30 dB@>3.8 MHz	30 dB@>25 MHz	30 dB@>114.0 MHz
LF Rejection	Not specified	30 dB@<1 MHz	30 dB@<15.0 MHz
Max Error Induced by 10% AM	0.2%@<5 kW, 1%@5 kW to 10 kW	0.2%@<5 kW, 1%@5 kW to 10 kW	0.2%@<1.5 kW, 1%@1.5 kW to 3 kW

MEASUREMENT

Accuracy	±1% at calibration frequencies and power levels, ±2% at other frequency and power levels Add 2% to uncertainty outside 25 ±5 °C
Uniformity	2% maximum unit to unit, at calibration frequency and power levels
Speed	2 readings per second
VSWR Range	1.00 to 2.00
Directivity	28 dB
Insertion Loss	<0.05 dB
Calibration Power Level	1700 W
Maximum Power	10 kW units: 12 kW max 6 kW units: 7.2 kW max

CONNECTORS

RF Connectors	Customer specified
----------------------	--------------------

SYSTEM

Recommended Calibration Interval	6 month. Performance before and performance after data to be supplied for units
Power Supply	External DC, 12 VDC, supplied from Bird 4421A Power Meter

CERTIFICATIONS

EMC	Designed to carry CE mark
------------	---------------------------

ENVIRONMENTAL

Operating Temperature	0 °C to 50 °C (32 °F to 122 °F)
Storage Temperature	-20 °C to 70 °C (-4 °F to 158 °F)
Humidity	95% max (non-condensing)
Altitude	Up to 10,000 ft (3,048 m)

PHYSICAL

Size	5.2 in x 2.5 in x 3.25 in (137 mm x 64 mm x 83 mm)
Weight	1 lb 13 oz (0.8 kg)

PRODUCT FEATURES

- Provides filtered measurement where the effects of amplitude modulation and harmonics need to be eliminated
- ±1% accuracy at specified frequencies and power levels
- Models do not need to be field calibrated before use and only need to be calibrated once every 6 months
- Plug and Play with the 4421A Series Multifunction Power Meter
- Dozens of connector options available

FOR USE WITH

- 4421A Multifunction Power Meters
- SCC7 Calibration Cart
- MSCC7 Calibration Cart

BENEFITS

- Enhances the set point accuracy of the CW RF source
- Optimizes source-to-source consistency across the fleet
- Delivers forward and reflected power measurements to 1% accuracy
- Maximizes the measurement accuracy of your main signal by filtering harmonics



RF Directional Thru-line Power Sensors

4028 SERIES

±2% ACCURACY

The Bird 4028 Series RF Directional Thru-line Power Sensors are designed specifically for use in high power LCD, TFT and Solar processing as well as other precision high power applications. Because accuracy is critical, these sensors are capable of ±2% accuracy at the calibrated frequency and power level which can improve accuracy and long-term repeatability for significant improvements on your process yields

4028	FREQUENCY RANGE	POWER RANGE
4028A250K	250 to 400 kHz	1.0 to 20 kW
4028A400K	400 to 550 kHz	1.0 to 20 kW
4028A2M	1.5 to 2.5 MHz	1.0 to 25 kW
4028A3M	2.5 to 3.5 MHz	1.0 to 25 kW
4028A4M	3.5 to 4.5 MHz	1.0 to 25 kW

	FREQUENCY RANGE	POWER RANGE
4028A10M	10 to 15 MHz	1.0 to 25 kW
4028A25M	25 to 30 MHz	1.0 to 25 kW
4028B3M	2.5 to 4 MHz	1.0 to 25 kW
4028B10M	10 to 15 MHz	1.0 to 25 kW
4028C10M	10 to 15 MHz	500 W to 50 kW

MEASUREMENT

Accuracy	±2% at calibration frequencies and power levels ±3% at other frequency and power levels Add 2% to uncertainty outside 25 ±10 °C
Accuracy, Rfl	Calculated from Fwd accuracy +, (Fwd Power/10 ^Δ {directivity/10})
VSWR, Max	2.00:1
Directivity, Min	28 dB
Insertion Loss, Max	0.05 dB (with female 7/16 DIN connectors)
Impedance, Nominal	50 Ohms
Speed	2 readings per second
Repeatability, multiple measurements, single sensor	±0.3% (95% c.l.) (with female 7/16 DIN connectors)
Calibration Power Level	1.7 kW

CONNECTORS

RF Connectors	
A Series	Customer specified
B Series	1 5/8" EIA Flanged
C Series	3 1/8" EIA Flanged
Sensor Interface	Latch-n-Lock

SYSTEM

Recommended Calibration Interval	1 year
Power Supply	Supplied by power meter via sensor cable

ENVIRONMENTAL

Operating Temperature	0 °C to 50 °C (32 °F to 122 °F)
Storage Temperature	-20 °C to 70 °C (-4 °F to 158 °F)
Humidity	95% max (non-condensing)
Altitude	10,000 ft (3,000 m)

PRODUCT FEATURES

- Specifically designed for use in high power LCD, TFT and Solar processing and other precision high power applications up to 50 kW
- ±2% accuracy at specified frequencies and power levels
- Models do not need to be field calibrated before use and only need to be calibrated once every year
- Plug and Play with the 4421A Series Multifunction Power Meter
- Dozens of connector options available
- Calibration traceable to the National Institute of Standards and Technology

FOR USE WITH

- 4421A Multifunction Power Meters
- SCC8 Calibration Cart

BENEFITS

- Enhances the set point accuracy of the CW RF source
- Optimizes source-to-source consistency across the fleet
- Delivers forward and reflected power measurements to 2% accuracy
- Supports measurements of higher power signals used in industrial processes

PHYSICAL

Size, Nom	
A Series	4.7 in x 3.2 in x 3.8 in (120 mm x 82 mm x 97 mm)
(w/o connectors)	
B Series	6.8 in x 3.5 in x 4.8 in (171 mm x 89 mm x 121 mm)
C Series	8.0 in x 5.2 in x 6.4 in (203 mm x 131 mm x 162 mm)
Weight, Nom	
A Series	1.7 lb (0.8 kg)
B Series	3.3 lb (1.5 kg)
C Series	7.3 lb (3.3 kg)

CERTIFICATIONS

EMC	Designed to carry CE mark
------------	---------------------------



RF Directional Thruline Power Sensors

4020 SERIES

±3% ACCURACY

Five models of the Bird 4020 Directional RF Power Sensor Series cover the frequency range of 100 kHz to 3 GHz and power range from 300 mW to 10 kW. These sensors have low insertion loss and full-scale accuracy $\pm 3\%$ for applications requiring accurate forward and reflected power measurement. Also offers direct plug-in operation with industry-standard Bird 4421A Series Multifunction Power Meters.

PRODUCT FEATURES

- Models cover frequency range of 100 kHz to 3 GHz
- Models cover power range from 300 mW to 10 kW
- Low insertion loss and full-scale accuracy $\pm 3\%$
- Direct plug-in operation with industry-standard Bird 4421A Series Multifunction Power Meters

FOR USE WITH

- 4421A Multifunction Power Meters
- SCC7 Calibration Cart
- MSCC7 Calibration Cart

BENEFITS

- Enhances the set point accuracy of the CW RF source
- Optimizes source-to-source consistency across the fleet
- Delivers forward and reflected power measurements to 3% accuracy
- Provides the flexibility of measuring various sources with its wideband capability

	4021	4022	4023A3G	4024	4025
Frequency Range	1.8 to 32 MHz	25 MHz to 1 GHz	800 to 3 GHz	1.5 to 32 MHz	100 kHz to 2.5 MHz
Power Range	300 mW to 1 kW (1.2 kW max)	300 mW to 1 kW (1.2 kW max)	300 mW to 200 W	3 W to 10 kW (12 kW max)	3 W to 10 kW (12 kW max)
Insertion Loss Max (with female "N" connector)	0.05 dB	0.05 dB, 25 to 512 MHz, 0.13 dB, 512 MHz to 1 GHz	0.15 dB	0.05 dB	0.05 dB
Insertion VSWR (with female "N" connector)	1.05:1	1.05:1: 25 to 512 MHz, 1.10:1: 512 MHz to 1 GHz	1.10:1	1.05:1	1.05:1
Directivity	30 dB	30 dB: 25 to 400 MHz 26 dB: 400 to 1000 MHz	28 dB	28 dB: 1.5-2.5 and 25 to 32 MHz 30 dB: 2.5 to 25 MHz	28 dB: 100 to 125 kHz 30 dB: 125 to 2500 kHz

MEASUREMENT

Impedance, Nominal 50 Ohms

Accuracy $\pm 3\%$ of reading, with no more than 1% AM, harmonics -50 dBc or less, terminating VSWR 2:1 or less

VSWR Range 1.00 to 2.00
(40.0 to 9.5 dB Return Loss)

CONNECTORS

RF Connectors N(F) standard, other customer specified from QC list appropriate for frequency and power.

SYSTEM

Recommended Calibration Interval Nominal 1 year

Power Supply External DC, 12VDC, supplied from Bird 4421A Power Meter

ENVIRONMENTAL

Operating Temperature 0 °C to 50 °C (32 °F to 122 °F)

Storage Temperature -20 °C to 70 °C (-4 °F to 158 °F)

Humidity 95% max (non-condensing)

Altitude Up to 10,000 ft (3,048 m)

PHYSICAL

Size 5.2 in x 2.5 in x 3.25 in
(137 mm x 64 mm x 83 mm)

Weight 1 lb 11 oz (0.8 kg)

CERTIFICATIONS

EMC Designed to carry CE mark



PRODUCT FEATURES

- 1% accurate measurement of RF voltage and current with a locked system
- Calculated impedance, RF power
- Multi-level pulse or CW waveforms
- 1-3 fundamental frequencies
- 4 harmonics per fundamental frequency
- 6 intermodulation products per fundamental pair
- Time-domain mode
- Tracking & Spectral search mode
- Ethernet enabled

APPLICATIONS

- Chamber to chamber matching
- RF process monitoring
- Impedance matching
- Troubleshooting RF delivery system
- Identify process drifts
- Harmonic levels up to 252 MHz are available for analysis
- Voltage, current, phase and delivered power comparison

Inline VI Probe System

BIRD DIAGNOSTIC SYSTEM (BDS2)

Using sophisticated parallel signal processing, the BDS2 simultaneously measures and reports voltage, current, and phase angle at multiple fundamental, harmonic and intermodulation frequencies. A robust frequency tracking algorithm guarantees accurate measurements under dynamic signal conditions. With this data, power and impedance are calculated at each frequency, giving users the ability to identify small discrepancies that may make the difference between a successful and a failed process.

MEASUREMENT

Measurements	Voltage, current, phase, frequency, impedance, power at frequencies selected by user
Frequency Range	307 kHz to 252 MHz (Sensor Dependent)
Frequency Resolution	100 kHz
Frequency Accuracy	±1 kHz
Number of Fundamentals	Up to 3 simultaneously. For more than 1 fundamental, choose from the following (or contact the factory for custom combinations): - 0.4, 13.56, 160 MHz - 0.4, 60 MHz - 1, 13.56 MHz - 2, 27.12, 60 MHz - 3.2, 40.68 MHz - 3.2, 60 MHz - 12.88, 40.68 MHz - 13.56, 100 MHz

Tracking Frequency Slew Rate	2 GHz/sec
Tracking Minimum Pulse Width	5 µsec
Number of Harmonics	Limited by the maximum number of measurement channels Tracking & Spectral search mode: 12 harmonics standard mode 6 in time domain mode
Update Rates	100 Hz typical
Network Protocol	Ethernet
RF Power Max	Determined by RF sensor, (Typically 10 kW or higher)
RF Connector	Custom or QC
Operating Modes	Tracking mode, Spectral Search mode

ENVIRONMENTAL

Receiver Operating Temperature	20 °C to 40 °C (68 °F to 104 °F)
Receiver Storage Temperature	-20 °C to 80 °C (-4 °F to 176 °F)
Cable Operating Temperature	0 °C to 100 °C (32 °F to 212 °F)
Cable Storage Temperature	-20 °C to 100 °C (-4 °F to 212 °F)
Sensor Operating/Storage Temperature	Refer to sensor specification
Humidity	85% max (non-condensing)
Air Pressure	745 mbar (equivalent to 2,500 m/ 8,200 ft max altitude)

POWER

Operating Power	15 VDC, 2.5 A nominal
------------------------	-----------------------

Inline VI Probe System BIRD DIAGNOSTIC SYSTEM (BDS2)

SYSTEM PROFILES

	VOLTAGE	CURRENT	PHASE ANGLE
Measurement	RF: 1 to 3000V _{rms} (Note 1)	0.1 to 100 A _{rms} (Note 1)	-180° to + 180°
Resolution	IEEE 754 Single Precision Floating Point		
Uncertainty 307 kHz to 1 MHz Locked System (Note 2)	for F _r , ±0.5 V or 1% of reading whichever is greater for F _n , ±1.0 V or 2% of reading, whichever is greater (95% confidence interval)	for F _r , ±0.05 A or 1% of reading whichever is greater for F _n , ±0.1 A or 2% of reading, whichever is greater (95% confidence interval)	Absolute Angle: F _r ≥ 10 V, 1A: ±1° F _r < 10 V, 1A: ±4°
Uncertainty 1 to 252 MHz Locked System (Note 2)	for F _r , ±0.1 V or 1% of reading whichever is greater for F _n , ±0.2 V or 2% of reading, whichever is greater (95% confidence interval)	for F _r , ±0.01 A or 1% of reading whichever is greater for F _n , ±0.02 A or 2% of reading, whichever is greater (95% confidence interval)	F _r ≥ 10 V, 1A: ±2° F _r < 10 V, 1A: ±6° (95% confidence interval)
Uncertainty 307 kHz to 1 MHz Unlocked System (Note 2)	for F _r , ±1.0 V or 2% of reading whichever is greater for F _n , ±2.0 V or 4% of reading, whichever is greater (95% confidence interval)	for F _r , ±0.1 A or 2% of reading whichever is greater for F _n , ±0.2 A or 4% of reading, whichever is greater (95% confidence interval)	Absolute Angle: F _r ≥ 10 V, 1A: ±1° F _r < 10 V, 1A: ±4°
Uncertainty 1 to 252 MHz Unlocked System (Note 2)	for F _r , ±0.2 V or 2% of reading whichever is greater for F _n , ±0.4 V or 4% of reading, whichever is greater (95% confidence interval)	for F _r , ±0.02 A or 2% of reading whichever is greater for F _n , ±0.04 A or 4% of reading, whichever is greater (95% confidence interval)	F _r ≥ 10 V, 1A: ±2° F _r < 10 V, 1A: ±6° (95% confidence interval)

*Contact factory for a custom designed sensor and custom frequency combinations.

Note 1: Maximum power is limited by the size of the RF frequency (25 kW max average power at 13.56 MHz).

Note 2: At customer specified frequencies.

SYSTEM COMPONENTS - UNLOCKED SYSTEM

	DESCRIPTION	CONNECTION OPTIONS
7001A900-2	BDS2 Single Ch. Receiver w/Ethernet	N/A
7001A900-3	BDS2 Single Ch. Receiver w/Ethernet and Serial	N/A
7001B040-5M	RF/Data Cable Set 5 M straight	N/A
7001A550-1-xx yy	Sensor, BDS2, QC Connector (Choose xx yy options from connection options)	Input (xx) and Output (yy) Connectors 01 = N(F) 12 = HN(F) 14 = 7/16(F) 34 = LC(F) 02 = N(M) 13 = HN(M) 15 = 7/16(M) 35 = LC(M)
7001A550-2	Sensor, BDS2, Protruding Dielectric Connection	N/A

*Contact Bird for additional connector options

SYSTEM KITS - LOCKED SYSTEM

	DESCRIPTION	CONNECTION OPTIONS
7001A500-1-xyxy	BDS2 Kit (Receiver, Cable and Sensor Kit), QC Connectors (Choose xx yy options from connection options)	Input (xx) and Output (yy) Connectors 01 = N(F) 12 = HN(F) 14 = 7/16(F) 34 = LC(F) 02 = N(M) 13 = HN(M) 15 = 7/16(M) 35 = LC(M)
7001A500-1-2	BDS2 Kit (Receiver, Cable and Sensor Kit), Protruding Dielectric Connection	N/A

*Contact Bird for additional connector options

TIME DOMAIN MEASUREMENT MODE (OPTIONAL)

	DESCRIPTION
License Options	Factory Install (7001A993-1) or Field Install (7001A993F-1)
Time Resolution	500 ns
Configurable Time Scale	0.1 to 10 ms
Average	Trace Average
Trigger	Voltage or current waveform, Rising or falling edge, External triggering, Upper/lower thresholds, Holdoff
Pre- and Post- Trigger Buffer	5% to 95%



PRODUCT FEATURES

- Suitable for use in a clean room environment
- Stainless steel cart is designed for easy transportation and effortless use
- Customizable with choice of power sensor and load configuration
- High return loss ensures minimal power measurement error contribution

INCLUDES

- **4421A Multifunction Power Meter** to display RF power readings with up to 1% accuracy
- **A 4020, 4027A or 4027F Series Power Sensor** for accurate RF measurement
- **An Ultra-Stable SC13 or High Power Load** for precision RF power regulation and control



MODEL 4421A

Single Sensor Calibration Cart

SCC7 SERIES

The SCC7 Calibration Cart provides the ideal solution for the calibration of RF generators. It combines a high accuracy Bird Power Sensor, a user friendly 4421A Multifunction Power Meter, and a low reflection load in an easily transportable mobile package. The system is indispensable for semiconductor fabs with multiple RF generators in various locations.

SYSTEM

Meter	4421A Multifunction Power Meter
Sensor Options	4020 Series, 4027A Series, or 4027F Series
Load Options	Ultra-Stable Load or High Power Load
Sensor Frequency Range	
4020 Series	100 KHz to 1000 MHz
4027A Series	250 KHz to 170 MHz
4027F Series	1.8 MHz to 63 MHz
Sensor Accuracy	
4020 Series	±3% across power and frequency range
4027A Series	±1% at calibration frequency and power levels
4027F Series	±1% at calibration frequency and power levels

Impedance	50 Ohms nominal
Power Requirements	115 or 230 VAC, 50/60 Hz
Connector Type	Customer specified
Operating Position	Vertical only
Casters	4 swivel
Material of Construction	Stainless steel cart

PHYSICAL

Size (fully assembled)	
1 kW & 2.5 kW Models	42 in x 20 in x 42 in (107 cm x 51 cm x 107 cm)
5 kW & 10 kW Models	52 in x 20 in x 42 in (132 cm x 51 cm x 107 cm)
Weight (fully assembled)	
1 kW & 2.5 kW Models	175 lb (80kg)
5 kW & 10 kW Models	250 lb (114kg)

ENVIRONMENTAL

Ambient Temperature	0 °C to 35 °C (32 °F to 95 °F), (10 kW Model 0 °C to 40 °C/ 32 °F to 104 °F)
Storage Temperature	-20 °C to 70 °C (-4 °F to 158 °F)
Humidity	85% max (non-condensing)
Altitude	Load derated above 5,000 ft (1,524 m)

CERTIFICATIONS

CE	CE Compliant
-----------	--------------

Single Sensor Calibration Cart

SCC7 SERIES CONFIGURATION GUIDE

RF POWER SENSORS - CHOOSE ONE (1)



4020 SERIES Directional ThruLine	FREQUENCY RANGE	POWER INPUT
4021	1.8 to 32 MHz	300 mW to 1 kW at 1.2 kW max
4022	25 to 1000 MHz	300 mW to 1 kW at 1.2 kW max
4024	1.5 to 32 MHz	3 W to 10 kW at 1.2 kW max
4025	100 to 2500 kHz	3 W to 10 kW at 1.2 kW max



4027A SERIES Precision Directional	FREQUENCY RANGE	POWER INPUT
4027A250k	250 to 400 kHz	3 W to 10 kW
4027A400k	400 to 550 kHz	3 W to 10 kW
4027A800k	800 to 950 kHz	3 W to 10 kW
4027A2M	1.5 to 2.5 MHz	3 W to 10 kW
4027A4M	3 to 5 MHz	3 W to 10 kW
4027A10M	10 to 15 MHz	3 W to 10 kW
4027A12M	10 to 15 MHz	300 mW to 1 kW
4027A25M	25 to 30 MHz	3 W to 9 kW
4027A35M	35 to 45 MHz	3 W to 7.5 kW
4027A60M	45 to 65 MHz	3 W to 6 kW
4027A100M	95 to 105 MHz	3 W to 4 kW
4027A150M	150 to 170 MHz	3.75 W to 3.75 kW



4027F SERIES Precision Filtered	FREQUENCY RANGE	POWER INPUT
4027F2M	1.8 to 2.2 MHz	100 W to 10 kW
4027F10M	12 to 15 MHz	100 W to 10 kW
4027F60M	57 to 63 MHz	100 W to 6 kW

RF LOADS - CHOOSE ONE (1)



HIGH POWER LOADS	FREQUENCY RANGE & VSWR	POWER INPUT
8251	DC to 1 GHz @ 1.1 max	1 kW
8890-300	DC to 1 GHz @ 1.1 max, 1 GHz to 2 GHz @ 1.25 max 2 GHz to 2.4 GHz @ 1.3 max	2500 W continuous
8921	DC to 1 GHz @ 1.1 max	5000 W continuous
8931-115	DC to 400 MHz @ 1.15 max 400 MHz to 1 GHz @ 1.20 max	10 kW continuous w/blower on 2.5 kW continuous w/blower off
8931-230	DC to 400 MHz @ 1.15 max 400 MHz to 1 GHz @ 1.20 max	10 kW continuous w/blower on 2.5 kW continuous w/blower off



ULTRA-STABLE LOADS	FREQUENCY RANGE & VSWR	POWER INPUT
8865SC13	DC to 28 MHz @ 1.1 max (VSWR less than 1.05:1)	1 kW
8890-300SC13	DC to 28 MHz @ 1.1 max (VSWR less than 1.05:1)	2.5 kW
8921SC13	DC to 28 MHz @ 1.1 max (VSWR less than 1.05:1)	5 kW
8931-115SC13	DC to 28 MHz @ 1.1 max (VSWR less than 1.05:1)	10 kW
8931-230SC13	DC to 28 MHz @ 1.1 max (VSWR less than 1.05:1)	10 kW



PRODUCT FEATURES

- Designed to support two power sensors
- Suitable for use in a clean room environment
- Stainless steel cart is designed for easy transportation and effortless use
- Customizable with choice of power sensor and load configuration
- High return loss ensures minimal power measurement error contribution

INCLUDES

- **4421A Multifunction Power Meter** to display RF power readings with up to 1% accuracy
- **Two 4020, 4027A, or 4027F Power Sensors** for accurate RF measurement
- **A High Power Load** for precision RF power regulation and control



MODEL 4421A

Dual Sensor Calibration Cart

MSCC7 SERIES

The MSCC7 Calibration Cart is a unique calibration solution in that it is designed to support two Power Sensors. In addition, it includes a user friendly 4421A Multifunction Power Meter and a high power load in an easily transportable mobile cart. The system is indispensable for semiconductor clean room applications.

SYSTEM

Meter	4421A Multifunction Power Meter
Sensor Options	Two 4020, 4027A, or 4027F Series
Load	One Bird High Power Load
Frequency Range	100 kHz to 30 MHz, depending on sensor
Sensor Accuracy	
4020 Series	±3% across power and frequency range
4027A Series	±1% at calibration frequency and power levels
4027F Series	±1% at calibration frequency and power levels

Impedance	50 Ohms nominal
Power Requirements	115 or 230 VAC, 50/60 Hz
Connector Type	Customer specified
Operating Position	Vertical only
Casters	4 swivel
Material of Construction	Stainless steel cart

ENVIRONMENTAL

Operating Temperature	0 °C to 35 °C (32 °F to 95 °F)
Storage Temperature	-20 °C to 70 °C (-4 °F to 158 °F)
Humidity	85% max (non-condensing)
Altitude	Load derated above 5,000 ft (1,524 m)

PHYSICAL

Size	52 in x 20 in x 42 in (132 cm x 51 cm x 107 cm)
Weight	290 lb (132 kg)

CERTIFICATIONS

CE	CE Compliant
-----------	--------------

Dual Sensor Calibration Cart

MSCC7 SERIES CONFIGURATION GUIDE

RF POWER SENSORS - CHOOSE TWO (2)



4020 SERIES Directional ThruLine	FREQUENCY RANGE	POWER INPUT
4021	1.8 to 32 MHz	300 mW to 1 kW at 1.2 kW max
4024	1.5 to 32 MHz	3 W to 10 kW at 12 kW max
4025	100 to 2500 kHz	3 W to 10 kW at 12 kW max



4027A SERIES Precision Directional	FREQUENCY RANGE	POWER INPUT
4027A250k	250 to 400 kHz	3 W to 10 kW
4027A400k	400 to 550 kHz	3 W to 10 kW
4027A800k	800 to 950 kHz	3 W to 10 kW
4027A2M	1.5 to 2.5 MHz	3 W to 10 kW
4027A4M	3 to 5 MHz	3 W to 10 kW
4027A10M	10 to 15 MHz	3 W to 10 kW
4027A12M	10 to 15 MHz	300 mW to 1 kW
4027A25M	25 to 30 MHz	3 W to 9 kW



4027F SERIES Precision Filtered	FREQUENCY RANGE	POWER INPUT
4027F2M	1.8 to 2.2 MHz	100 W to 10 kW
4027F10M	12 to 15 MHz	100 W to 10 kW

RF LOADS - CHOOSE ONE (1)



HIGH POWER LOADS	FREQUENCY RANGE & VSWR	POWER INPUT
8921A100	DC to 30 MHz @ 1.1 max (less than 1.05 typical)	5 kW
8931A400-115	DC to 30 MHz @ 1.1 max (less than 1.05 typical)	10 kW
8931A400-230	DC to 30 MHz @ 1.1 max (less than 1.05 typical)	10 kW



PRODUCT FEATURES

- Designed for effortless, immediate use
- Suitable for use in a clean room environment
- High return loss ensures minimal power measurement error contribution
- Stainless steel cart with locking wheels is designed for easy transportation and effortless use

INCLUDES

- **4421A Multifunction Power Meter** to display RF power readings with up to 2% accuracy
- **A 4028 Series Power Sensor** for accurate RF measurement
- **A Bird Moduload** with low reflection 50 Ohm terminations that can dissipate up to 25 kW

High Power Calibration Cart

SCC8 SERIES

The SCC8 Calibration Cart provides the ideal solution for the calibration of high power RF generators with power measurement up to 25 kW. It combines the high-accuracy Bird 4028 Series Power Sensor, a user-friendly 4421A Multifunction Power Meter, and a Bird Moduload in an easily transportable mobile package.



MODEL 4421A

RF POWER SENSORS - CHOOSE ONE (1)



4028 SERIES Directional ThruLine	FREQUENCY RANGE	POWER INPUT
4028A10M	10 to 15 MHz	1 kW to 25 kW
4028A250K	250 to 400 kHz	1 kW to 20 kW
4028A25M	25 to 30 MHz	1 kW to 25 kW
4028A2M	1.5 to 2.5 MHz	1 kW to 25 kW
4028A3M	2.5 to 3.5 MHz	1 kW to 25 kW
4028A400K	400 to 550 kHz	1 kW to 20 kW
4028A4M	3.5 to 4.5 MHz	1 kW to 25 kW
4028B10M	10 to 15 MHz	1 kW to 25 kW
4028B3M	3 to 4 MHz	1 kW to 25 kW

SYSTEM

Meter	4421A Multifunction Power Meter
Sensor	4028 Series
Load	Bird Moduload
Frequency Range	250 kHz - 30 MHz, depending on sensor
Accuracy	±2% (2s) at calibration frequency and power levels, ±3% (2s) of reading at other power levels and frequencies within sensor range (add 2% to uncertainty outside 25 ±10 °C)
Impedance	50 Ohms nominal
Power Requirements	115 or 230 VAC, 50/60 Hz
Connector Type	Customer specified

Sensor VSWR	1.05 max (32.2 dB return loss)
Load VSWR	1.1 max (26.4 dB return loss)
Coolant	100% water or 35% industrial ethylene glycol / 65% water, 9 quarts (8.5 liters), forced air cooling
Particle Generation	156 per cfm (0.5 µm) 29 per cfm (1 µm) 0 per cfm (3 µm)
Casters	4 locking swivel
Material of Construction	Stainless steel cart

PHYSICAL

Size	39.5 in x 21.5 in x 39.5 in (100.3 cm x 54.6 cm x 100.3 cm)
Weight	240 lb (109 kg)

ENVIRONMENTAL

Operating Temperature	5 °C to 30 °C (41 °F to 86 °F), < 25 kW, 100% water, (derate sensor accuracy outside 25 ±10 °C), 5 °C to 35 °C (41 °F to 95 °F), < 20 kW, 100% water, (derate sensor accuracy outside 25 ±10 °C)
Storage Temperature	0 °C to 25 °C (32 °F to 77 °F), < 25 kW, 35% ethylene glycol/65% water 0 °C to 35 °C (32 °F to 95 °F), < 20 kW, 35% ethylene glycol/65% water
Humidity	85% max (non-condensing)
Altitude	Load derated above 5,000 ft (1,524 m)

CERTIFICATIONS

CE	CE Compliant
-----------	--------------



MADE IN USA

RF Calibration Kit

SMK-3000 SERIES

The SMK-3000 calibration kits are precision, high power calibration standards used to calibrate RF radios, wattmeters, directional couplers and other high-power RF test equipment in the field or metrology lab. Available in a single- or dual-sensor option, these kits provide a much faster time-to-calibration with lab precision and accuracy. Covering a frequency range of 1 to 1000 MHz, these kits enable users to calibrate at 3% accuracy in just minutes.

KIT INCLUDES

- Low band Directional Power Sensor
- Medium band Directional Power Sensor
- High band Directional Power Sensor
- 4421A Multifunction Power Meter to display RF power readings with up to 1% accuracy
- Rugged carrying case
- Latch & Lock cable



MODEL 4421A

SMK-3000 SERIES	PRODUCT TYPE	FREQUENCY RANGE	ACCURACY	POWER RANGE
SMK-3003-LB	3% Kit	1 to 10 MHz	±3% of reading (2 σ)	1 to 1000 W
SMK-3003-MB	3% Kit	10 to 100 MHz	±3% of reading (2 σ)	1 to 1000 W
SMK-3003-HB	3% Kit	100 to 1000 MHz	±3% of reading (2 σ)	1 to 1000 W

MEASUREMENT

Directivity	28 dB minimum
Impedance	50 Ohms
Insertion Loss	< .05 dB
Insertion VSWR	< 1.05:1

UNCERTAINTY

Forward Power Uncertainty*	SMK-3003A Series: ±3% of reading*, 2 σ Calibration plane location: Connector output
Reflected Power Uncertainty*	±3% of reading*, 2 σ Calibration plane location: Connector output
VSWR Uncertainty	-27 dB to -10 dB, see chart

*Measurement conditions: Harmonics <35 dBc, Load VSWR <1.1:1, AM modulation <1%

CONNECTORS

RF Input	N(M), Quick Change (QC)
RF Output	N(F), Quick Change (QC)
Display	1-meter Latch & Lock coiled cable

ENVIRONMENTAL

Operating Humidity	20% to 50%
Operating Temperature	19.4 °C to 26.1 °C (73 °F to 6 °F)
Storage Temperature	-20 °C to 70 °C (-4 °F to 158 °F)

PHYSICAL

Weight (excluding 4421A)	5 lb (2.27 kg)
---------------------------------	----------------



RF POWER SENSORS

Simple to Complex Power Measurement for Communications and Process Control

Bird provides power sensor solutions for virtually all types of RF applications. From simple true-average power measurement applications to complex waveforms associated with today's modern communication systems. Bird's plug and play solution provides an inline measurement that can be displayed on multiple types of devices providing basic power measurements, to highly accurate or statistical readings. You can rely on Bird sensor products to meet the needs of your unique applications.



DIGITAL POWER METER DISPLAY

Page 41



WIDEBAND

Page 42 -43



BASIC

Page 44



STATISTICAL

Page 45



DIRECTIONAL

Page 46 - 47

Rugged Solutions for Measuring a Broad Range of Critical RF Parameters

Bird offers a comprehensive range of RF Sensors, meters and monitors, all easy-to-use solutions for users of all skill levels. The RF power sensors range from the economical, element based Directional Power Sensor to the multi-functional Wideband Power Sensor capable of measuring a broad range of critical RF parameters.

From simple true-average power measurement applications, to the measurement of the complex waveforms associated with modern communications systems, where peak power or burst power measurement are essential. All Bird RF Sensors are rugged, highly accurate, and provide high value power measurement solutions.

1 WHAT IS AN RF POWER SENSOR?

The most common RF transmitter measurement is RF power. Before performing any other tests, the engineer or technician will want to confirm that the source is outputting power, at the correct level. RF power is the first indication of a system's health.

Most power sensors fall into three categories: thermistors, thermocouples and diode detectors. Thermistors operate by changing resistance due to a change in temperature. The change in temperature is a result from converting RF energy into heat.

Thermocouples are heat-based sensors and are considered true averaging detectors. Thermocouples generate a voltage due to temperature differences at the junction of two dissimilar metals.

Diode detectors convert or rectifies an RF signal to DC with an amplitude that is proportional to the input power. For a certain range of power levels, a detector's output voltage is proportional to the square-root of power otherwise called the square-law range.

2 SIGNAL TYPES AFFECT MEASUREMENT UNCERTAINTY

For a radio signal to carry information, it must be varied or modulated - there are various types of modulation, each best in different situations. It is important to know what type of modulation is being measured since signal waveform effects measurement uncertainty.

RF modulation techniques are roughly divided into four types: Analog modulation, Digital modulation, Pulse modulation, and Spread spectrum method. Analog modulation is typically used for AM, FM radio, and short-wave broadcasting. Digital modulation involves transmission of binary signals (0 and 1) found in digital broadcast TV and radio, mobile communications, tactical military radios etc.

Among the types of RF power measurements, the steady state of a CW tone is perhaps the simplest. Peak power, such as the overshoot of an RF pulse or IQ waveform, is the maximum value over some period of time. The power measurement can be averaged across a time period, such as across a series of RF pulses, yielding the average power.

For many mobile communication signals, RF power can be integrated over a frequency band. Digitally modulated signals tend to be noise-like in nature and often have specified average and peak power values. A true averaging sensor will provide average power measurements for all types of signal formats from continuous wave (CW) to complex digital modulations.

Amplitude Modulation (AM)

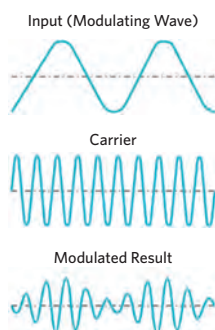

Frequency Modulation (FM)

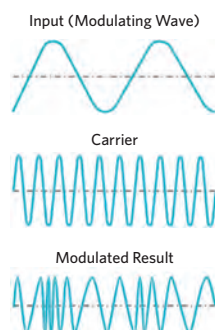

Digital Modulation

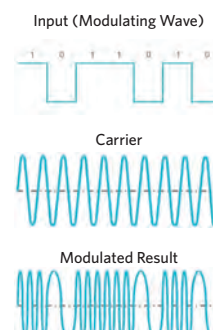

3 BASIC FACTORS TO CONSIDER WHEN SELECTING AN RF POWER SENSOR

- **Frequency Range:** the range of frequencies that the sensor will cover.
- **Dynamic Range:** the range of power over which a sensor is capable of making useful measurements.
- **Accuracy** of the measurement based on uncertainty factors
- **Zero Calibration Requirements**
- **Speed** of measurements

4 POWER SENSOR MEASUREMENTS

Choosing the right power sensor for your application is dependent on the signal characteristics you need to measure.

True Average Power is the RF power level independent of the waveform. The measurement is "true" regardless of whether the waveform is CW, AM, FM, PM, pulsed, has a large crest factor, or consists of some other complex waveform.

Peak Power measures the highest single power of a pulsed RF signal waveform. This is important for evaluating signals where peaks outside the pulse lead to distortion.

Burst Average Power are appropriate RF power measurements for GSM and TDMA signal waveforms. They are characterized by long pulse widths and long periods.

Crest Factor measures the ratio between average and peak RF power, in dB. If the crest factor is too large, the transmitter will not be able to handle the peak powers and amplitude

amplitude distortion will occur. Crest factor can also detect overdrive and overshoot problems.

CCDF (Duty Cycle) is a statistical characterization of the time-domain waveform that completely describes the power characteristics of the signal. A CCDF graph relates average signal power (X axis) to signal power statistics (Y axis) such that each point on the CCDF curve shows how much time a signal spends at or above a given power level. The power level is expressed in dB relative to the average signal power level.

Statistical Signal Analysis (7022 Series Only) provides the statistical measurement capability required to accurately characterize modern communications system waveforms independent of the modulation technique or channel access method used in the system.

5 HOW TO DISPLAY YOUR DATA

Most RF power sensors are used in conjunction with a separate power meter or software. Bird offers the following options for measurement viewing; 5000-NG, VPM3, RF Meter App for Android and Windows. Whether you are using a PC or a stand-alone meter, you can view data logging, power versus time graphs, and offset table that enable quick and accurate measurements.





RF Power Meter Display

5000-NG

Bird's new 5000-NG RF Power Meter Display provides another dimension for viewing your RF power meter measurements when connected to Bird's Power Sensors. Operating over a broad frequency range using one of Bird's USB RF power sensors, the 5000-NG allows you to instantly view measurements like True Average Power, VSWR, Return Loss, and more. A giant leap forward, this unit delivers high quality interface and RF power measurements at your fingertips for installation and maintenance both on the go or in an R & D lab environment.

MEASUREMENT

Frequency Range	2 MHz to 6 GHz with external power sensors (not included)
Key Measurements	True Average Power (Forward and Reflected), VSWR, Return Loss, rho, Match Efficiency, Peak Power, Peak to Average Ratio, PEP, Crest Factor, Burst and Burst Average Power, CDF, CCDF, Confidence %, IEEE 194 Pulse Parameters, Sensor Temperature

CONNECTORS

USB	Micro USB PC interface & charging and Standard USB power sensor interface
------------	---

SYSTEM

Display	Full-Color 8" 1280 x 800-pixel display w/backlight
Operating System	Android 5.1
Languages	English
Storage	16 GB
Data Transfer	USB drive, PC, WiFi, or Bluetooth
Battery Type	Rechargeable, 3.7 V/6200 mAh lithium

Battery Operating Time (display in sleep mode)	24 hrs. continuous usage w/5012 Series or 7022 sensors, 48 hrs. continuous usage w/all other sensors
Battery Charge Time	6 hours typical
Recommended Calibration Interval	No calibration required (sensor calibration recommended)
Power Supply	AC: 100 to 240 V / 50-60 Hz; DC: 5V/2.5 A
Upgradeability	Firmware field-upgradeable via USB port
Additional Functions	Data logging, numerical & graphing display
Sensor Detection	Automatic USB Sensors WiFi 802.11 Network

ENVIRONMENTAL

Operating Temperature	-20 °C to 60 °C (-4 °F to 140 °F)
Storage Temperature	-20 °C to 80 °C (-4 °F to 176 °F)
Altitude	Up to 15,000 ft (4,572 m)

PHYSICAL

Size	9.2 in x 6.3 in x 1.1 in (233 mm x 160 mm x 28 mm)
Weight	1.3 lb (0.59 kg)

PRODUCT FEATURES

- Rugged, 8" color touch screen display for worry-free field use
- Automatic sensor detection that works with over 10 supported Bird USB field sensors
- Data logging, 7-day memory
- 48 hours of battery life for extended use
- Android 5.1 operating system provides enhanced security
- 5.0 Megapixel camera
- Tried and true power measurement with simple set-up
- Data logging, numerical & graphics display
- Easy data transfer via USB or WiFi

KEY MEASUREMENTS WHEN PAIRED WITH A BIRD POWER SENSOR

- True Average Power (Forward and Reflected)
- VSWR, Return Loss, rho, Match Efficiency
- Peak Power, Peak to Average Ratio, Crest Factor, PEP
- Burst and Burst Average Power
- CDF, CCDF, Confidence %
- IEEE 194 Pulse Parameters
- Sensor Temperature

COMPATIBLE SENSORS

5012D	Wideband Power Sensor, 350 MHz to 4 GHz, 150 mW to 150 W, 400 W Peak
5014	Directional Power Sensor, 2 MHz to 2.7 GHz, 125 mW to 1 kW, Full scale
5016D	Wideband Power Sensor, 350 MHz to 4.0 GHz, 25 mW to 25 W, 60 W Peak
5017D	Wideband Power Sensor, 25 MHz to 1.0 GHz, 500 mW to 500 W, 1300 W Peak
5018D	Wideband Power Sensor, 150 MHz to 4.0 GHz, 100 mW to 25 W, 60 W Peak
5019D	Wideband Power Sensor, 25 MHz to 1.0 GHz, 100 mW to 100 W, 250 W Peak
7020-1-010101	Wideband Power Sensor, 350 MHz to 4.0 GHz, 150 mW to 150 W
7020-1-020101	Wideband Power Sensor, 350 MHz to 4.2 GHz, 150 mW to 150 W
7020-1-030301	Wideband Power Sensor, 25 MHz to 1.0 GHz, 500 mW to 500 W
7022-1-020201	Wideband Power Sensor, 350 MHz to 6.0 GHz, 250 mW to 500 W



PRODUCT FEATURES

- Digital, analog, and multi-carrier signals regardless of modulation type
- Measures True Average Power, Peak Power and Duty Cycle directly with exceptional accuracy
- Calculations performed: VSWR, Return Loss, Reflection Coefficient, Crest Factor, Average Burst Power and CCDF
- Sensor plug and plays with 5000-NG Power Meter Display and Bird's RF Meter App

BENEFITS

- Monitor and perform maintenance for monitoring while DUT (Device Under Test) is in-service
- No field calibration required, annual factory calibration only

SUPPORTED MODULATIONS

- Wide coverage of applications: WPS measures: Analog Cellular, Digital Cellular, 3G, 4G, Tetra, APCO/P25, Trunking, CDMA, TDMA, WCDMA, GSM, Transportation, Tactical Military, Radar, Avionics, Marine, LMR, Analog Broadcast, Digital Broadcast, GSM, GPRS, EDGE, UMTS, HSDPA, Bluetooth, Fire, GPS, NPSPAC, Paging, Project 25, Public Safety, Telematics, Utilities, WIMAX and WLAN

Wideband Power Sensors

5012D, 5016D, 5017D, 5017D-AV, 5018D, 5019D

±4% ACCURACY

Bird's Wideband Power Sensor Series provides high performance and accurate in-line field measurements that never require field calibration. These Thruline sensors can measure average, peak, or burst power, VSWR, crest factor, and Complementary Cumulative Distribution Function (CCDF). They can be used with Bird's 5000-NG Power Meter Display, Site Analyzers, SignalHawk, Bird's Virtual Power Meter Software(VPM3) and the Bird's RF meter App.

	5012D	5016D	5017D	5017D-AV	5018D	5019D
Frequency Range	350 MHz to 4.0 GHz	350 MHz to 4.0 GHz	25 MHz to 1.0 GHz	100 MHz to 1.3 GHz	150 MHz to 4.0 GHz	25 MHz to 1.0 GHz
Power Range	150 mW to 150 W Avg 400 W Peak	25 mW to 25 W Avg 60 W Peak	500 mW to 500 W Avg 1300 W Peak*	500 mW to 500 W Avg 1300 W Peak*	100 mW to 25 W Avg 60 W Peak	100 mW to 100 W 260 W Peak
Insertion VSWR	<1.05 from 0.35 to 2.5 GHz <1.10 from 2.5 to 4 GHz	<1.05 from 0.35 to 2.5 GHz <1.10 from 2.5 to 4 GHz	<1.05	<1.05	<1.05 from 0.15 to 2.5 GHz <1.10 from 2.5 to 4 GHz	<1.05
Insertion Loss	<0.05 dB from 0.35 to 1.0 GHz <0.1 dB from 1 to 4 GHz	<0.05 dB from 0.35 to 1.0 GHz <0.1 dB from 1 to 4 GHz	<0.05 dB	<0.1 dB	<0.05 dB from 0.35 to 1.0 GHz <0.1 dB from 1 to 4 GHz	<0.05 dB
Directivity	30 dB up to 3.0 GHz, 28 dB from 3.0 to 4.0 GHz	30 dB up to 3.0 GHz, 28 dB from 3.0 to 4.0 GHz	29 dB 25 MHz to <50 MHz 30 dB from >50 MHz to 1000 MHz	28 dB up to 100 MHz, 30 dB from 100 to 1000 MHz	30 dB up to 3.0 GHz, 28 dB from 3.0 to 4.0 GHz	28 dB up to 100 MHz, 30 dB from 100 to 1000 MHz

*Derate maximum average power rating from 500 W at 300 MHz to 100 W at 1 GHz using a straight line on a log-log scale

SYSTEM

Power Supply	USB Port: Less than one low-power, USB load DC Input Connector: 7-18, VDC at less than 0.1A
Impedance	50 Ohms nominal
Data Logging	Requires 5000-NG or VPM3

CONNECTORS / INTERFACES

Connectors	N Female (Both)
DPM	DB9 proprietary interface
PC Interface (1)	RS-232, 9600 Baud, no parity, 8 data bits, 1 stop bit, DB9
PC Interface (2)	USB 2.0 Type B

ENVIRONMENTAL

Operating Temperature	-10 °C to 50 °C (14 °F to 122 °F)
Storage Temperature	-40 °C to 80 °C (-40 °F to 176 °F)

PHYSICAL

Size	4.8 in x 4.6 in x 1.3 in (120 mm x 82 mm x 97 mm)
Weight	1.2 lb (.54 kg)

CERTIFICATIONS

CE	EMC EN 61326-1-2006
Mechanical Shock & Vibration	IAQ MIL-PRF-28800F class3

STANDARD ACCESSORIES

5A2653-10	USB Cable
VPM3	Virtual Power Meter
920-50125	Instruction Book
920-VPM3	VPM Instruction Book

OPTIONAL ACCESSORIES

PA-MNME	Male N to Male 7/16 (DIN)
PA-MNFE	Male N to Female 7/16 (DIN)
5A2226	Power Supply, Intl
5A2229	Power Supply, US
5A2264-09-MF-10	DB9 Cable, 10 in
5A2653-OR5NLS	USB Interface Cable, 15 cm

Wideband Power Sensors 5012D, 5016D, 5017D, 5017-AV, 5018D, 5019D

AVERAGE POWER

MODEL	AVERAGE FORWARD POWER RANGE	PEAK POWER RANGE	ACCURACY, AVERAGE FORWARD POWER	MINIMUM FORWARD POWER FOR REFLECTED MEASUREMENT	RETURN LOSS	VSWR
5012D	150 mW to 150 W	400 W Peak	±4% of reading, + 0.05 W	0.5 W	0.0 to 23 dB	1.15 to 99.9
5016D	25 mW to 25 W	60 W Peak	±4% of reading, + 0.008 W	0.1 W	0.0 to 23 dB	1.15 to 99.9
5017D/5017D-AV*	500 mW to 500 W	1300 W Peak	±4% of reading, + 0.17 W	0.5 W	0.0 to 23 dB	1.15 to 99.9
5018D	100 mW to 25 W	60 W Peak	±4% of reading, + 0.008 W	0.1 W	0.0 to 23 dB	1.15 to 99.9
5019D	100 mW to 100 W	260 W Peak	±4% of reading, + 0.04 W	0.3 W	0.0 to 23 dB	1.15 to 99.9

*Derate maximum average power rating from 500 W at 300 MHz to 100 W at 1GHz using a straight line on a log-log scale

BURST AVERAGE POWER

MODEL	BURST AVERAGE POWER RANGE	BURST WIDTH	REPETITIONS RATE	DUTY CYCLE (D)	ACCURACY, BURST AVERAGE POWER
5012D	4 W to 150 W avg	1 µs to 5 ms	5 Hz, Min	.002 to 1.0	±6% of reading, + 0.05 W
5016D	.7 W to 25 W avg	1 µs to 5 ms	5 Hz, Min	.002 to 1.0	±6% of reading, + 0.008 W
5017D/5017D-AV	13.5 W to 500 W avg	1 µs to 5 ms	5 Hz, Min	.002 to 1.0	±6% of reading, + 0.17 W
5018D	.7 W to 25 W avg	1 µs to 5 ms	5 Hz, Min	.002 to 1.0	±6% of reading, + 0.008 W
5019D	2.7 W to 100 W avg	1 µs to 5 ms	5 Hz, Min	.002 to 1.0	±6% of reading, + 0.04 W

PEAK ENVELOPE POWER & ACCURACY**

MODEL	PEAK ENVELOPE POWER RANGE	BURST WIDTH > 200 MS	1 MS < BURST WIDTH < 200 MS	0.5 MS < BURST WIDTH < 1 MS	BURST WIDTH < 0.5 MS
5012D	4 W to 400 W	±7% of reading, + 0.20 W	±10% of reading, + 0.40 W	±15% of reading, + 0.40 W	±20% of reading, + 0.40 W
5016D	.7 W to 60 W	±7% of reading, + 0.05 W	±10% of reading, + 0.10 W	±15% of reading, + 0.10 W	±20% of reading, + 0.10 W
5017D/5017D-AV	13.5 W to 1300 W	±7% of reading, + 0.70 W	±10% of reading, + 1.40 W	±15% of reading, + 1.40 W	±20% of reading, + 1.40 W
5018D	.7 W to 60 W	±7% of reading, + 0.05 W	±10% of reading, + 0.10 W	±15% of reading, + 0.10 W	±20% of reading, + 0.10 W
5019D	2.7 W to 260 W	±7% of reading, + 0.13 W	±10% of reading, + 0.26 W	±15% of reading, + 0.26 W	±20% of reading, + 0.26 W

**For temperatures above 35 °C or below 15 °C add 3.0% to stated accuracies

COMPLEMENTARY CUMULATIVE DISTRIBUTION FUNCTION (CCDF)

MODEL	CCDF MEASUREMENT RANGE	THRESHOLD MEASUREMENT RANGE	MEASUREMENT UNCERTAINTY	LEVEL SET ACCURACY
5012D	0.1 to 100%	4.0 W to 400 W	±2%	As Peak Envelope Power Accuracy + 2.0%
5016D	0.1 to 100%	0.7 W to 25 W	±2%	As Peak Envelope Power Accuracy + 2.0%
5017D/5017D-AV	0.1 to 100%	13.5 W to 500 W	±2%	As Peak Envelope Power Accuracy + 2.0%
5018D	0.1 to 100%	0.7 W to 25 W	±2%	As Peak Envelope Power Accuracy + 2.0%
5019D	0.1 to 100%	2.7 W to 100 W	±2%	As Peak Envelope Power Accuracy + 2.0%

CREST FACTOR

MODEL	CREST FACTOR MEASUREMENT RANGE	ACCURACY, CREST FACTOR
5012D	150 mW to 150 W	Linear Sum of Peak and Average Power Accuracies
5016D	25 mW to 25 W	Linear Sum of Peak and Average Power Accuracies
5017D/5017D-AV	500 mW to 25 W	Linear Sum of Peak and Average Power Accuracies
5018D	25 mW to 25 W	Linear Sum of Peak and Average Power Accuracies
5019D	100 mW to 100 W	Linear Sum of Peak and Average Power Accuracies



PRODUCT FEATURES

- Digital, analog, and multi-carrier signals regardless of modulation type
- Measures forward and reflected power and VSWR to troubleshoot system failures
- Monitor and perform maintenance for monitoring while DUT(Device Under Test) is in-service
- Economical power measurement solution
- Utilizes the complimentary Virtual Power Meter (VPM3) application
- Supported by 5000-NG Power Meter Display
- No field calibration required

SUPPORTED MODULATIONS

- Wide coverage of applications: Analog Cellular, Digital Cellular, 3G, 4G, Tetra, APCO/P25, Trunking, CDMA, TDMA, WCDMA, GSM, Transportation, Tactical Military, Radar, Avionics, Marine, LMR, Analog Broadcast, Digital Broadcast, GSM, GPRS, EDGE, UMTS, HSDPA, Bluetooth, Fire, GPS, NPSPAC, Paging, Project 25, Public Safety, Telematics, Utilities, WIMAX and WLAN

Basic Power Sensors

7020 SERIES

±4% ACCURACY

The 7020 Series of RF Power Sensors is an economical, plug and play solution to your power measurement needs. The 7020 determines and reports Forward and Reflected True Average Power and VSWR over a wide frequency range of 25 MHz to 1.0 GHz or 350 MHz to 4.2 GHz. It also never requires field calibration, only requires factory calibration once per year and is traceable to National Institute of Standards and Technology (NIST).

	7020-1-030301	7020-1-010101	7020-1-020101
Frequency Range	25 MHz to 1.0 GHz	350 MHz to 4.0 GHz	350 MHz to 4.2 GHz
Power Range	0.5 W to 500 W*	0.15 W to 150 W	0.15 W to 150 W

*Derate maximum average power rating from 500 W at 300 MHz to 100 W at 1 GHz using a straight line on a log-log scale.

MEASUREMENT

Accuracy	±4% of reading + 0.05 W Add 3% to uncertainty above 35 °C or below 15 °C
Forward Power for Reflected Measurement	5.0 W min
Peak/Average Ratio	12 dB max
Insertion Loss	0.1 dB max
Insertion VSWR	1.10 max
VSWR Range	1.15 to 99.9
Impedance	50 Ohms nominal
Response Time	100 ms
PIM Rating	-130 dBc @ 460 MHz
Directivity	<-30 dB, 350 to 1000 MHz min <-28 dB, 1000 to 4000 MHz min <-24 dB, 4000 to 6000 MHz min

CONNECTORS

RF Connectors	N Female
Display Interface	USB 2.0 Type 'B' with "SeaLATCH" locking USB connector

SYSTEM

Recommended Calibration Interval	1 year
Power Supply	5 VDC from USB host, 35 mA current draw
Data Logging	with VPM3 software
Upgradeability	Firmware field-upgradeable via the USB port

ENVIRONMENTAL

Operating Temperature	-30 °C to 60 °C (-22 °F to 140 °F)
Storage Temperature	-40 °C to 80 °C (-40 °F to 176 °F)
Humidity	95% max (non-condensing)
Altitude	Up to 15,000 ft (4,572 m)

PHYSICAL

Size	4.8 in x 2.6 in x 1.3 in (122 mm x 66 mm x 32 mm)
Weight	1 lb (0.45 kg)

CERTIFICATIONS

CE	EMC Directive (2004/108/EC): European Standard EN 61326-1:2006 – Electronic Equipment for measurement, control and laboratory use EMC Requirements: in accordance with EMC Directive (2004/108/EC)
RoHS	Compliant
Mechanical Shock & Vibration	Mil-PRF-28800F Class 3

STANDARD ACCESSORIES

5A2653-6L2	SeaLATCH USB Cable
VPM3	Virtual Power Meter
920-7020S	Instruction Manual (Sensor)
920-VPM3	Instruction Manual (VPM3)

COMPATIBLE DEVICES

SA-XT Series	SeaLATCH USB Cable
5000-NG	Digital Power Meter Display
Bird RF Meter	Android App



Statistical Power Sensor

7022-1-020201

±3% ACCURACY

The 7022-1-020201 Statistical RF Power Sensor is a rugged, easy to use field instrument that uses statistical sampling techniques. In modern communications, signal average power, although important is no longer a sufficient control variable. These communication signals often require more diagnostic measurements. In the statistical mode, the power sensor measures the percentage of time the signal exists at a specific peak-to-average ratio. In the time domain mode, the sensor adds a variety of functions similar to an oscilloscope to our standard suite of measurements.

MEASUREMENT

Measurement Type	ThruLine Power
Frequency Range	350 MHz to 6 GHz
Frequency Measurement Accuracy	±3% of reading with CW signals
Power Measurement Range*	0.25 W to 500 W average, 1500 W peak
Dynamic Range	33 dB
Peak to Average Ratio	12 dB, absolute peak power limited to 1500 W
Impedance	50 Ohms nominal
Insertion Loss	0.05 dB max
Insertion VSWR	1.065, 350 to 2500 MHz max 1.12, 2500 to 6000 MHz max
Directivity, Min	<-30 dB, 350 to 1000 MHz, <-28 dB, 1000 to 6000 MHz <-24 dB, 4000 to 6000 MHz (min)

*Derate maximum average power rating from 500 W at 350 MHz to 100 W at 6 GHz using a straight line on a log-log scale.

CONNECTORS

RF Connectors	N Female
Display Interface	USB 2.0 Type B (USBTMC)
Trigger Input	BNC female (1MΩ Impedance; 3 V High, 1.2 V Low)

SYSTEM

Factory Calibration	NIST traceable
Field Calibration	No field calibration required
Data Logging	Yes, with the VPM3 software
Power Supply	USB Port
Sample Rate	44 M samples/s max
Time Resolution	50 nSec to 10 Sec
Time Base Accuracy	.01%
Display Refresh Rate	10 times/sec (Limited by communication)
Video Bandwidth	Settable: 20 MHz (none), 5 MHz, 400 kHz, 4.5 kHz
Points per screen	1001 max

ENVIRONMENTAL

Operating Temperature	-10 °C to 50 °C (14 °F to 122 °F)
Storage Temperature	-40 °C to 80 °C (-40 °F to 176 °F)
Humidity	95% max (non-condensing)
Altitude	Up to 15,000 ft (4,572 m)

PHYSICAL

Size	5.8 in x 4.8 in x 1.3 in (147 mm x 122 mm x 33 mm)
Weight	1.5 lb (0.68 kg)

PRODUCT FEATURES

- Digital, analog, and multi-carrier signals regardless of modulation type
- Provides Forward and Reflected Power, Peak/Pulse Power, Time Domain and Statistical Measurements
- Three operating modes: Conventional Time Domain and Statistical
- Analytical results of Signal of Interest using CCDF parameters
- Detailed breakdown of a single or multiple pulses
- Isolate and identify specific breakpoints with the use of markers
- Includes a wide range of IEEE pulse parameters

SUPPORTED MODULATIONS

- Analog Cellular, Digital Cellular, 3G, 4G, Tetra, APCO/P25 Phase 1 & 2, DMR, MOTOTRBO, Trunking, CDMA, TDMA, WCDMA, GSM, Transportation, Tactical Military, Radar, Avionics, Marine, LMR, Analog Broadcast, Digital Broadcast, GSM, GPRS, EDGE, UMTS, HSDPA, Bluetooth, Fire, GPS, NPSPAC, Paging, Public Safety, Telematics, Utilities, WIMAX, WLAN, EVDO, UMTS, LTE, and HDT

CERTIFICATIONS

CE	EMC Directive (2004/108/EC): European Standard: EN 61326 - Electrical Equipment for measurement, control and laboratory use
Mechanical Shock & Vibration	Mil-PRF-28800F Class 3
RoHS	Compliant

STANDARD ACCESSORIES

5A2653-6L2	USB SeaLatch™ Cable
VPM3	Virtual Power Meter
920-7022	Manual for Statistical Power Sensor
920-VPM3	Manual for Virtual Power Meter
5A2918-11-6	BNC / BNC Trigger Cable



Directional ThruLine® Power Sensors

5014
±5% ACCURACY

The Bird 5014 ThruLine directional power sensor is a flexible power measurement solution that can be tailored to a multitude of applications. Measures True Average Power or Peak Power using Bird elements.

No field calibration is required and factory calibration is only suggested once per year. Calibration is traceable to the National Institute of Standards and Technology (NIST), providing additional confidence in your RF measurements.

MEASUREMENT

Frequency Range	Element dependent, 2 MHz to 1000 MHz
Power Range	Element dependent, 125 mW to 1 kW full
Accuracy	True Average Power: ±5% of reading (15 °C to 35 °C); ±7% of reading (-10 °C to 50 °C) Peak Power: ±8% of full scale
Peak/Average Ratio	10 dB maximum with DPM elements
Insertion VSWR	1.05:1 from 0.45 to 1000 MHz (with N connectors)
Impedance	50 Ohms
Directivity	30 dB typical (element dependent)

Dynamic Range	16 dB
Pulse Width Parameters	>100 MHz: 800 ns minimum 26 to 99 MHz: 1.5 µs minimum 2 to 25 MHz: 15 µs minimum
Pulse Rep. Rate Peak	15 pps minimum
Pulse Duty Factor	1 x 10 ⁻⁴ minimum

CONNECTORS

RF Connectors	QC Type. Female N normally supplied
Display Interface	5014: USB 1.1 Type 'B'

PRODUCT FEATURES

- Bird's Directional Power Sensor measures True Average Power using APM/DPM elements
- Measure Peak Power using 43 Series elements.
- Supported modulation types include: AM, FM, CW, 8VSB, COFDM
- Provides Forward & Reflected RF power, VSWR, Return loss, Reflection Coefficient
- Operate your sensor by connecting USB cable to an Android device utilizing the Bird RF Meter app, power meter display (5000-NG), or VPM3 on a windows 7 PC. (Windows RF Meter Software for newer OS)
- Virtual Power Meter (VPM3) included

COMPATIBLE DEVICES

5000-NG	SH-60S-TC
SK-4500-TC	SH-60S-AOA
SK-6000-TC	VPM3
RF Meter App	Windows 10

SYSTEM

Settling Time	<2.5 seconds
Recommended Calibration Interval	1 year
Power Supply	From host instrument via cable connection

ENVIRONMENTAL

Operating Temperature	-10 °C to 50 °C (14°F to 122 °F)
Storage Temperature	-40 °C to 75 °C (-40 °F to 167 °F)
Humidity	95% max (non-condensing)

PHYSICAL

Size (excluding connectors)	2.3 in x 2.1 in x 3.5 in (58 mm x 53 mm x 89 mm)
Weight	1.12 lb (0.51 kg)

Directional Thruline® Power Sensors

5014

DPM ELEMENT SELECTION GUIDE

FREQUENCY RANGE	FORWARD POWER RANGE	REFLECTED POWER RANGE	FORWARD ELEMENT	REFLECTED ELEMENT
25 to 60 MHz	1.25 to 50 W 12.5 to 500 W	125 mW to 5 W 1.25 to 50 W	DPM-50A DPM-500A	DPM-5A DPM-50A
50 to 125 MHz	1.25 to 50 W 12.5 to 500 W 25 to 1.0 kW	125 mW to 5 W 1.25 to 50 W 25 to 100 W	DPM-50B DPM-500B DPM-1000B	DPM-5B DPM-50B DPM-100B
100 to 250 MHz	1.25 to 50 W 12.5 to 500 W 62.5 to 2.5 kW	125 mW to 5 W 1.25 to 50 W 6.25 to 250 W	DPM-50C DPM-500C DPM-2500C	DPM-5C DPM-50C DPM-250C
200 to 500 MHz	125 mW to 5 W 1.25 to 50 W 12.5 to 500 W	12.5 mW to 500 mW 125 mW to 5 W 1.25 to 50 W	DPM-5D DPM-50D DPM-500D	DPM-.5D DPM-5D DPM-50D
400 to 800 MHz	125 mW to 5 W 1.25 W to 50 W 2.5 W to 100 W 12.5 W to 500 W 25 W to 1 kW	12.5 mW to 500 mW 125 mW to 5 W 250 mW to 10 W 1.25 W to 50 W 2.5 W to 100 W	DPM-5E-400 DPM-50E-400 DPM-100E-400 DPM-500E-400 DPM-1000E-400	DPM-.5E-400 DPM-5E-400 DPM-10E-400 DPM-50E-400 DPM-100E-400
800 to 1000 MHz	125 mW to 5 W 1.25 W to 50 W 2.5 W to 100 W 12.5 W to 500 W 25 W to 1 kW	12.5 mW to 500 mW 125 mW to 5 W 250 mW to 10 W 1.25 W to 50 W 2.5 W to 100 W	DPM-5E-800 DPM-50E-800 DPM-100E-800 DPM-500E-800 DPM-1000E-800	DPM-.5E-800 DPM-5E-800 DPM-10E-800 DPM-50E-800 DPM-100E-800

Note: Elements must be chosen from the same series and the forward and reflected elements chosen in a 10:1 power ratio

APM ELEMENT SELECTION GUIDE

POWER RANGE	FREQUENCY BANDS (MHz)						
	2 to 30	25 to 60	500 to 125	100 to 250	200 to 500	400 to 800	800 to 960
1 W	—	—	APM-1B	APM-1C	—	APM-1E-400	APM-1E-800
2.5 W	—	—	APM-2.5B	—	APM-2.5D	APM-2.5E-400	APM-2.5E-800
5 W	APM-5H	APM-5A	APM-5B	APM-5C	APM-5D	APM-5E-400	APM-5E-800
10 W	APM-10H	APM-10A	APM-10B	APM-10C	APM-10D	APM-10E-400	APM-10E-800
25 W	—	—	APM-25B	APM-25C	APM-25D	APM-25E-400	APM-25E-800
50 W	APM-50H	—	—	APM-50C	APM-50D	APM-50E-400	APM-50E-800
100 W	APM-100H	APM-100A	APM-100B	APM-100C	APM-100D	APM-100E-400	APM-100E-800
250 W	APM-250H	APM-250A	APM-250B	APM-250C	APM-250D	APM-250E-400	APM-250E-800
500 W	APM-500H	—	APM-500B	APM-500C	APM-500D	APM-500E-400	APM-500E-800
1000 W	APM-1000H	—	APM-1000B	APM-1000C	—	—	—

Note: Elements must be chosen from the same series and the forward and reflected elements chosen in a 10:1 power ratio

43 SERIES ELEMENT SELECTION GUIDE

- Select from Element Tables 1,2,3,4,6,13, and 14 starting on page 74
- 43 series elements can be used to measure average power if peak to average ratio is close to 1



RF POWER MONITORS

Monitor, Measure and Protect Your RF System

Bird's RF Power Monitor family includes a range of products that not only measure forward and reflected power and VSWR, but also provide hard contact alarms to protect your system in the event of a system failure. Depending on which system you need, the monitoring device can be configured to allow you to take control of the RF network installation from transmitters to the antenna.



CHANNEL POWER MONITORS

Page 51 - 53



TRANSMITTER POWER MONITOR

Page 54 - 55



BROADCAST POWER MONITOR

Page 56



RF MONITORS & ALARMS

Page 57 - 59

**MADE IN
USA** 

RF Power Monitors

Anyone responsible for a multiple-site, multiple-channel land mobile radio communications system knows that management of even just a single site can often be a complex task. Failures or degradation in performance multiple trips to the site to correct the issue.

Bird's RF Power Monitors includes a range of products that not only measure power and VSWR but also provide hard contact alarms, logging, and remote monitoring to protect your system in the event of a system failure.

Remote 24/7 monitoring of transmitter RF power output and antenna performance in multi-channel and trunked radio networks allow you to efficiently monitor the performance of transmitters, transmission lines, and antennas at many remote sites.

1 WHAT ARE THE VARIOUS COMPONENTS WITHIN A COMMUNICATIONS SYSTEM THAT NEED TO BE MONITORED?

Transmitter output monitoring - Identify radios with reduced output. Monitoring will allow repair or replacement prior to failure

Isolator performance - Identify isolator degradation leading to an increase in reflected power that may harm the transmitter

Combiner loss by channel - Identify increases in insertion loss due to combiner detuning or drifting

Antenna VSWR by channel - Detailed monitoring of the antenna to identify frequency related VSWR shifts due to weather, aging, etc.

Composite antenna VSWR - Identify failures in the post combiner feedline or antenna

2 TYPE OF COMMUNICATION AND ALERTS

Determining the type of communication is required to manage a site is dependent on the type of system you choose. Here are some typical ways that sensors and monitoring devices can communicate feedback on the health of your system.

- **Local User Interface** - This typically is a local rack panel that provides setup and configuration menu's, and diagnostic screens.
- **Web Server management** - Webpage dedicated for setup and display of all measurement parameters and alarm functions
- **Data files** that can be logged and exported to view historical information and perform trend analysis
- **Configurable alarms** - alarm levels are settable by the user, locally or remotely
- **SNMP Enabled with traps** for end user interface with an SNMP management system

3 WHAT ARE SOME QUESTIONS YOU SHOULD ASK WHEN SELECTING YOUR COMMUNICATION SYSTEM?

Whether you need a Broadcast solution to change over from analog to digital signals or need to monitor radio performance, combiner loss and antenna/feedline characteristics, we have a solution for you.

- How many antennas will I have? How many sites?
- What is the provided input voltage at the site/sites?
- What type of network connection do I have? Cellular, Ethernet?
- Do you have an SNMP Manager?
- What are the frequencies I need to measure?
- How much power am I measuring?

POWER MONITOR SELECTION GUIDE

	CPM	TPM	BPME
Product Family	Channel Power Monitors	Transmitter RF Power Monitor	Broadcast RF Power Monitors
Measurement Types	Monitors radio performance, combiner loss and antenna feedline characteristics	Used to measure true average power signals, both forward and reflective, in broadcast systems	Used to measure and monitor VSWR and power
Application	Provide the user with continuous information by utilizing hard contact and SNMP formats	Calibrated coupling ports and accurate power measurement	Monitor RF power and VSWR continuously and set alarms
Data Access	Serial or Ethernet	DB9 Interface options	RS-232 or Ethernet
Market	16 channels analog or digital land mobile radio systems	Broadcast Solution	Broadcast Solution
Interface	Built in Web Server or Panel Access	Optional Display panel	Display Panel or PC

POWER SENSOR SELECTION GUIDE

	4042	4042E	4043	4043E	4044
Type	Channel, Directional	Channel, Directional	Composite, Directional	Composite, Directional	Non-Directional
Frequency Range	100 MHz to 1 GHz 30 MHz to 200MHz	100 MHz to 1 GHz	118 MHz to 940 MHz (Model Dependent)	118 MHz to 940 MHz (Model Dependent)	118 MHz to 940 MHz (Model Dependent)
Measurement Range- FWD Power	10 W to 500 W	10 W to 500 W	25 W to 500 W 2.5 W to 50 W(LP)*	25 W to 500 W 2.5W to 50 W(LP)*	2.5 W to 125 W
Measurement Range- RFL Power	1 W to 50 W	1 W to 50 W	2.5 W to 50 W .25 W to 5 W(LP)*	2.5 W to 50 W .25 W to 5 W(LP)*	N/A
Measurement Accuracy	±5% of reading	±5% of reading	±5% of reading	±5% of reading	±5% of reading
Channel Bandwidth	6.25, 12.5, 25 kHz selectable	6.25, 12.5, 25 kHz selectable	N/A	N/A	N/A
Connector Options	01 = N(F) 02 = N(M) 03 = 4.3/10(F) 04 = 4.3/10(M) 05 = 7/16 DIN(F) 06 = 7/16 DIN(M)	01 = N(F) 02 = N(M) 03 = 4.3/10(F) 04 = 4.3/10(M) 05 = 7/16 DIN(F) 06 = 7/16 DIN(M)	01 = N(F) 02 = N(M) 03 = 4.3/10(F) 04 = 4.3/10(M) 05 = 7/16 DIN(F) 06 = 7/16 DIN(M)	01 = N(F) 02 = N(M) 03 = 4.3/10(F) 04 = 4.3/10(M) 05 = 7/16 DIN(F) 06 = 7/16 DIN(M)	01 = N(F) 02 = N(M) 03 = 4.3/10(F) 04 = 4.3/10(M)
Interface	RJ-25	RJ-25	RJ-25	RJ-25	RJ-25
Communication	RS-458	Ethernet	RS-458	Ethernet	N/A
Monitors	Up to 16 Channels	Up to 16 Channels	N/A	N/A	N/A

*Low power version





Channel Power Monitor

CPM SERIES

Comprised of a central processor and a variety of sensors, the Bird Channel Power Monitor System can be set up to monitor radio performance, combiner loss, and antenna/feedline characteristics providing continuous information on the health of each component it monitors.

This multiple-channel power monitoring system is capable of continuously monitoring power and VSWR performance simultaneously for up to 16 analog or digital channels and is scalable to accommodate any size radio system operating between 118 and 940 MHz. The CPM evaluates and monitors LMR systems by checking the key elements of the transmission path in real time and alerting users of degraded performance or failures.

CPM SOLUTIONS

- Power monitor display and sensors allow you to build a system around your needs
- Monitor up to 16 non-directional and 16 directional sensors simultaneously
- Measures forward, reflected, composite and individual channel power as well as antenna system VSWR
- Monitoring of the system is accomplished via interface with the front panel or accessed through the built in web server and web page
- Configurable alarming for high and low level power and high antenna VSWR, utilizing hard contact and SNMP formats
- Standard Push-to-Talk (PTT) compatibility

3141 PRODUCT FEATURES

- The central display user interface via the front panel display and buttons or via an Internet connection and a network accessible web page (GUI interface)
- Designed for a 19 in rack and 1 RU
- Two digital sensor inputs, up to 16 digital sensors may be serially connected (daisy-chained)
- 16 analog inputs. RJ-25 Connectors are used to connect each analog channel to an analog sensor
- Three user-defined inputs which can be connected to sensors/contacts of the customer's choice

MONITOR SELECTION GUIDE



3141 SERIES	INPUT VOLTAGE	INPUT CURRENT	FUSE RATING
3141A15	+15 VDC (supplied by 115/230 VAC Adapter)	<3 Amps	5 Amp
3141A48	±48 VDC (+48 or -48)	<1 Amp	1.25 Amp



Power Sensors

4042, 4043, & 4044 SERIES

Bird power sensors used with the CPM, support analog and digitally modulated radio. Our non-directional sensor model 4044 and directional sensor model 4043 are both available in seven models covering bands from 118 to 940 MHz. The 4042 channel sensor covers a frequency range of 100 to 1000 MHz. It is capable of measuring up to 16 single channels in the presence of multiple channels at the output of a frequency combiner. Analog and digital power sensors may be used together with a single CPM.

4042 SERIES FEATURES

- Frequency Range 100 to 1000MHz
- Monitor antenna failure and radio power output simultaneously
- Single PTT power alarms allowing cycling through the frequencies
- Install post-combiner to monitor antenna VSWR

4043 SERIES FEATURES

- Frequency range includes 7 bands between 118 and 940 MHz
- Provides composite power monitoring
- Alarm limits can be set by the user to provide alerts when crossed

4044 SERIES FEATURES

- Measures output of either analog or digitally modulated radios up to 125 W
- Ideal for use at the input to each channel of the transmit combiner
- Frequency bands of 118 to 940 MHz

4042 SERIES Channel, Directional	FREQUENCY RANGE	MAX FORWARD POWER MEASUREMENT RANGE	MAX REFLECTED POWER MEASUREMENT	CONNECTOR OPTIONS	
4042-1-410505-yyzz	30 MHz to 200 MHz	10 W to 500 W	10 dB below Forward Power Range	Input (yy) and Output (zz) Connectors 01 = N(F) 03 = 4.3/10(F) 05 = 7/16 DIN(F) 02 = N(M) 04 = 4.3/10(M) 06 = 7/16 DIN(M)	
4042-1-430505-yyzz	100 MHz to 1000 MHz	25 W to 500 W			
4043 SERIES Composite, Directional	FREQUENCY RANGE	MAX FORWARD POWER MEASUREMENT RANGE	MAX REFLECTED POWER MEASUREMENT	ACCURACY	CONNECTOR OPTIONS
4043-1-420505-yyzz	118 MHz to 144 MHz	25 W to 500 W	10 dB below Forward Power Range	±5% of reading	Input (yy) and Output (zz) Connectors 01 = N(F) 02 = N(M) 03 = 4.3/10(F) 04 = 4.3/10(M) 05 = 7/16 DIN(F) 06 = 7/16 DIN(M)
4043-1-440505-yyzz	144 MHz to 244 MHz				
4043-1-450505-yyzz	380 MHz to 450 MHz				
4043-1-460505-yyzz	450 MHz to 512 MHz				
4043-1-470505-yyzz	762 MHz to 806 MHz				
4043-1-480505-yyzz	806 MHz to 869 MHz				
4043-1-490505-yyzz	896 MHz to 940 MHz				
4043-1-500505-yyzz	225 MHz to 400 MHz				
4044 SERIES Non-Directional	FREQUENCY RANGE	POWER RANGE	ACCURACY	CONNECTOR OPTIONS	
4044-1-420404-yyzz	118 MHz to 144 MHz	2.5 W to 125 W	±5% of reading	Input (yy) and Output (zz) Connectors 01 = N(F) 03 = 4.3/10(F) 02 = N(M) 04 = 4.3/10(M)	
4044-1-440404-yyzz	144 MHz to 244 MHz				
4044-1-450404-yyzz	380 MHz to 450 MHz				
4044-1-460404-yyzz	450 MHz to 512 MHz				
4044-1-470404-yyzz	762 MHz to 806 MHz				
4044-1-480404-yyzz	806 MHz to 869 MHz				
4044-1-490404-yyzz	896 MHz to 940 MHz				



Ethernet Power Sensors

4042E & 4043E SERIES

A powerful approach to antenna and power monitoring for smaller radio communications systems and paging networks. With internal processing capabilities, it eliminates the need for additional monitoring and processing equipment. These Ethernet power sensors connect directly to the Internet or private IP network and can be accessed remotely for set-up and monitoring by displaying measurement information via a web browser on a Web UI.

4042E FEATURES

- Frequency Range 100 to 1000 MHz
- Monitor antenna failure and radio power output simultaneously
- Single PTT power alarms allowing cycling through the frequencies
- Install a post-combiner to monitor antenna VSWR

4043E FEATURES

- Frequency range includes 7 bands between 118 and 940 MHz
- Provides composite power monitoring
- Alarm limits can be set by the user to provide alerts when crossed

APPLICATIONS

Commercial, industrial, and government land-mobile-radio (LMR) wireless-communications systems including:

- Public Safety
- Marine/Coast Guard
- Private Networks
- Railroad

4042E/4043E	FREQUENCY RANGE (ff)	FORWARD POWER (ww)	COMMUNICATION INTERFACE (xx)	CONNECTOR OPTIONS
4042E-1-ffwwxx-yyzz	41 = 30 to 200 MHz 43 = 100 to 1000 MHz	05 = 10 W to 500 W	03 = Ethernet	Input (yy) and Output (zz) Connectors 01 = N(F) 04 = 4.3/10(F) 02 = N(M) 05 = 7/16 DIN(F) 03 = 4.3/10(F) 06 = 7/16 DIN(M)
4043E-1-ffwwxx-yyzz	42 = 118 MHz to 144 MHz 44 = 144 MHz to 244 MHz 45 = 380 MHz to 450 MHz 46 = 450 MHz to 512 MHz 47 = 762 MHz to 806 MHz 48 = 806 MHz to 869 MHz 49 = 896 MHz to 940 MHz 50 = 225 MHz to 400 MHz*	02 = .25 W to 5 W 03 = 2.5 W to 50 W 05 = 25 W to 500 W	03 = Ethernet	Input (yy) and Output (zz) Connectors 01 = N(F) 04 = 4.3/10(F) 02 = N(M) 05 = 7/16 DIN(F) 03 = 4.3/10(F) 06 = 7/16 DIN(M)

MEASUREMENT

Impedance	50 Ohms nominal
Insertion Loss	0.2 dB max
Insertion VSWR	1.15 max
Directivity	25 dB min
Peak/Average Ratio	12 dB max
Accuracy	±5% of reading

CONNECTORS

Interface	Ethernet 10/100/1000BASE-T (auto-sensing) Version 2.0/IEEE 802.3
RF Connectors	Input: N(F), N(M), 4.3/10(F), 4.3/10(M) Output: N(F), N(M), 4.3/10(F), 4.3/10(M)

SYSTEM

Supported Protocols	TCP/IP Hosted web page, SNMP v2.0 Client
Power Supply	5.5-25 VDC, 3W max, 0.08 in (2 mm) power jack. 15 VDC adapter included
Operating Position	Any
Push-to-Talk input (PTT) for spurious alarm suppression	NO or NC logic (software selectable), 3.5mm terminal push-lock, optically isolated

ENVIRONMENTAL

Humidity	95% max, non-condensing
Altitude	15,000 ft (4,572 m) max
Operating Temp.	0 °C to 50 °C (32 °F to 122 °F)
Storage Temp.	-40 °C to 80 °C (-40 °F to 176 °F)

PHYSICAL

Size (without connectors)	3.8 in x 5.2 in x 1.4 in (97 mm x 132 mm x 36 mm)
Weight	0.6 lb (.27 kg)

CERTIFICATIONS

Certifications	CE, RoHS
-----------------------	----------

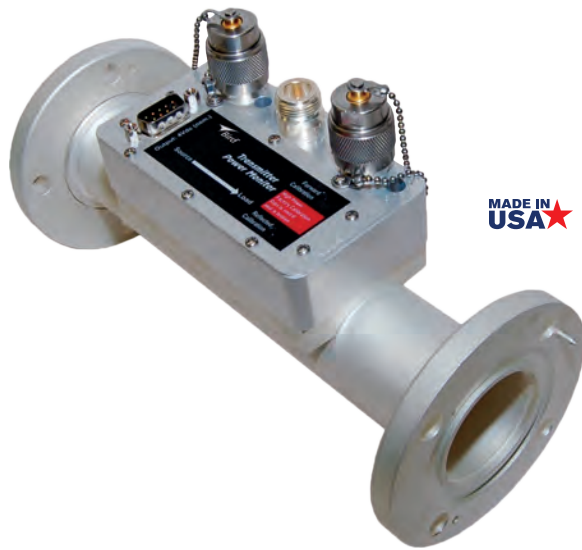

Transmitter Power Monitor

TPM SERIES

Bird's Transmitter Power Monitor (TPM) is used to measure power signals and perform spectral analysis of broadcast systems. The TPM series can be calibrated during broadcast operation so there is never any need to remove from service, eliminating downtime.

In-line calibration assures that it retains the original National Institute of Standards and Technology (NIST) calibration.

PRODUCT FEATURES

- A power measurement solution designed for operation inside the transmitter or after the combiner
- In-line calibration capability allows for greater accuracy in a single application (with an accurate power reference)
- Accurately measures true average power for digitally modulated systems
- 7/8 in, 1 5/8 in, and 3 1/8 in, 50 Ohm lines available for FM, VHF, and UHF broadcast frequencies
- DB9 output provides a linear DC voltage output from 0 to 4 volts allowing for a wide variety of interface options

3140A4 DISPLAY OPTION

- Available in a 4 channel configuration
- When combined with a Bird model 3140A4 Transmit Power Meter (TPM) display, a complete adjustment system is achieved. The display supplies a visual indication of Forward and Reflected power being sampled by the inline TPM.
- Multiple TPM's can be selected (only one per channel setting) to give the operator an overall condition of the transmitter system.



MEASUREMENT

Frequency Ranges	54 to 88 MHz 88 to 108 MHz 174 to 216 MHz 470 to 806 MHz
Forward Power Range	See chart
Reflected Power Range	10% of forward power range
Measurement Type	In-line, true average power
Peak/Average Ratio	10 dB max
Coupler Directivity	26 dB min, 30 dB typical
Accuracy	±5% of reading
Dynamic Power Range	16 dB

SYSTEM

Outputs	DB9 voltage I/O
Calibration Cycle	Annual*
Display Options	3140A4: 4 channel

ENVIRONMENTAL

Operating Temperature	0 °C to 50 °C (32 °F to 122 °F)
Storage Temperature	-20 °C to 80 °C (-4 °F to 176 °F)
Humidity	95% ±5% max non-condensing
Altitude	up to 10,000 ft (3,048 m)

PHYSICAL

Weight	TPM7: 3.5 lb TPM1: 5.5 lb TPM3: 8.0 lb 3140: 2.5 lb
---------------	--

CERTIFICATIONS

CE	EMC EN 61326-1:2006 and Safety EN 61010-1:2001
-----------	--

* Standard calibration cycle of 1 year for reverification, but can be recalibrated by the customer with an accurate power reference. See the Application note on TPM calibration at www.bird-electronic.com

Transmitter Power Monitor

TPM SERIES

MONITOR SELECTION GUIDE

LINE SIZE	VHF (54 to 216 MHz)		UHF (470 to 806 MHz)	
	FORWARD POWER RANGE	POWER DESIGNATOR	FORWARD POWER RANGE	POWER DESIGNATOR
7/8 in	15 W to 500 W 30 W to 1.0 kW 80 W to 2.5 kW 150 W to 5 kW	Low Medium High Very High	15 W to 500 W 30 W to 1 kW 80 W to 2.5 kW	Low Medium High
1 5/8 in	30 W to 1.0 kW 80 W to 2.5 kW 150 W to 5 kW 300 W to 10 kW	Low Medium High Very High	30 W to 1.0 kW 80 W to 2.5 kW 150 W to 5.0 kW	Low Medium High
3 1/8 in	150 W to 5 kW 300 W to 10 kW 800 W to 25 kW 1.5 kW to 50 kW	Low Medium High Very High	150 W to 5.0 kW 300 W to 10 kW 800 W to 25 kW	Low Medium High

Note: For best accuracy, pick the lowest power range that includes your maximum average operating power.

7/8 IN LINE SECTION PART NUMBER CONFIGURATION GUIDE

MODEL	INPUT CONNECTORS	OUTPUT CONNECTORS	FREQUENCY BAND	POWER**	UHF SUB-BAND
TPM7: 7/8 in line section	A = N(F) H = DIN(F) B = N(M) J = DIN(M) C = LC(F) K = UHF(F) D = 7/8 EIA L = UHF(M)	A = N(F) H = DIN(F) B = N(M) J = DIN(M) C = LC(F) K = UHF(F) D = 7/8 EIA L = UHF(M)	L = 54 to 88 MHz F = 88 to 108 MHz H = 174 to 216 MHz U = 470 to 806 MHz	L = Low M = Medium H = High S = Very High	A = 470 to 554 MHz B = 554 to 638 MHz C = 638 to 722 MHz D = 722 to 806 MHz

Example: TPM7BJ-FL-B = TPM7 (7/8 in line section), N Male Input Connector, DIN Male Output Connector, 88 to 108 MHz frequency band, low power, with a 554 to 638 UHF sub-band.

1 5/8 IN OR 3 1/8 IN LINE SECTIONS PART NUMBER CONFIGURATION GUIDE

MODEL	LINE INTERFACE****	FREQUENCY BAND	POWER**	UHF SUB-BAND
TPM1 (1 5/8 in line section) TPM3 (3 1/8 in line section)	U = Unflanged, Recessed Center Conductor UF = Unflanged, Flush Center Conductor	L = 54 to 88 MHz F = 88 to 108 MHz H = 174 to 216 MHz U = 470 to 806 MHz	L = Low M = Medium H = High S = Very High	A = 470 to 554 MHz B = 554 to 638 MHz C = 638 to 722 MHz D = 722 to 806 MHz

** see Chart for power ranges

*** Other sizes and power ranges available upon request

****For flanged, leave blank

Example: TPM3U-FL-B = TPM3 (3 1/8 in line section), Unflanged Recessed Center Conductor, 88 to 108 MHz frequency band, low power, with a 554 to 638 UHF sub-band.

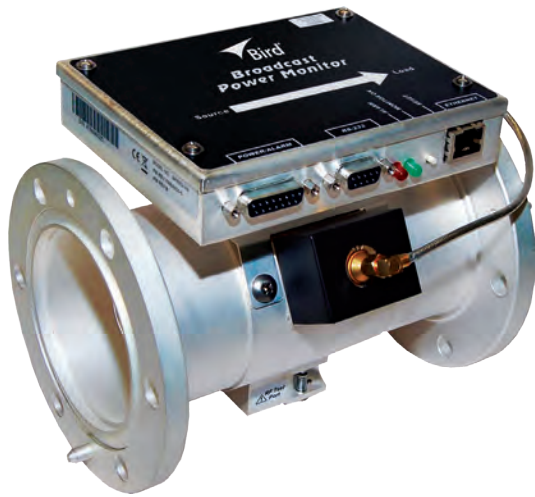

Broadcast Power Monitor

BPME SERIES

PRODUCT FEATURES

- Integral RF test port enables mask compliance testing, as well as monitoring of spectrum, modulation, frequency & RF envelope performance
- Ethernet & RS-232 Enabled - Future-ready remote monitoring, control & instant alarm alert
- Data Logging Capabilities - System trends and anomalies can be detected before failures

OPTIONAL DISPLAY

- 3129A is a rackmount remote power monitor panel



Bird's Broadcast power monitors are a compact, microprocessor-controlled instruments intended for long-term VSWR and power monitoring. Get continual, accurate power readings and VSWR monitoring with around-the-clock remote access from any web enabled device. This unit can be configured in the field for frequency and channel and offers integration of forward and reflected elements into the RF Detection/Control Circuit for added stability and greater dynamic range.

MONITOR SELECTION GUIDE

LINE SIZE	POWER DESIGNATOR	VHF (45 MHz to 230 MHz)	UHF (470 MHz to 890 MHz)
		FORWARD POWER RANGE	FORWARD POWER RANGE
7/8 in	Low	5 W to 500 W	2.5 W to 250 W
	Medium	20 W to 2000 W	10 W to 1000 W
	High	50 W to 5000 W	25 W to 2500 W
1 5/8 in	Low	20 W to 2000 W	5 W to 500 W
	Medium	80 W to 8 kW	20 W to 2000 W
	High	200 W to 20 kW	50 W to 5000 W
3 1/8 in	Low	50 W to 5000 W	25 W to 2500 W
	Medium	200 W to 20 kW	100 W to 10 kW
	High	500 W to 50 kW	250 W to 25 kW
4 1/16 in & 4 1/2 in	Low	100 W to 10 kW	40 W to 4 kW
	Medium	400 W to 40 kW	150 W to 15 kW
	High	1000 W to 100 kW	400 W to 40 kW
6 1/8 in	Low	200 W to 20 kW	80 W to 8 kW
	Medium	800 W to 80 kW	300 W to 30 kW
	High	2000 W to 200 kW	750 W to 75 kW

MEASUREMENT

Frequency Range*	See chart
Forward/Reflected Power Range*	See chart
Measurement Type	In-line, True Average Power
Peak/Average Ratio	10 dB
Coupler Directivity	26 dB min, 30 dB typical
Accuracy	±5% of reading
Dynamic Power Range	20 dB

* Frequency and power level depend on line section, sensor element, and selected display option. While designed for digital broadcast, the Broadcast Power Monitor can be used for a wide range of frequencies, power levels, and applications. Please contact the factory to discuss your application and requirements.

SYSTEM

Alarms	VSWR, no/low forward power, high forward power
Outputs	SPDT relay contact
Calibration Cycle	Annual
Display Options	BPME PC Software or 3129A rackmount digital RF display

INTERFACES

Ethernet Port	10Base-T or 100Base-TX (auto sensing)
Protocols	ARP, UDP/IP, TCP/IP, Telnet, ICMP, SNMP, DHCP, BOOTP, TFTP, Auto IP, and HTTP Security: 256-bit encryption; Serial RS-232, 9600 baud, no parity, 8 data bits, 1 stop bit, no handshake

ENVIRONMENTAL

Operating Temperature	0 °C to 50 °C (32 °F to 122 °F)
Storage Temperature	-20 °C to 80 °C (-4 °F to 176 °F)
Humidity	95% ±5% max non-condensing
Altitude	up to 10,000 ft (3,048 m)

CERTIFICATIONS

CE	EMC EN 61326-1:2006 and Safety EN 61010-1:2001
----	--



Transmitter RF Power Monitor Display

MODEL 3140A4

The 3140A4 Meter Panel is the standard display and power supply for the TPM Series of Transmitter RF Power Monitors. The panel is a 4 channel configuration and fits in a standard 2U rack.

A single 15 V power supply is supplied with each panel providing power to multiple TPM RF monitors. The display supplies a visual indication of Forward and Reflected power being sampled by the inline TPM.

Multiple TPM's can be selected (only one per channel setting) to give the operator an overall condition of the transmitter system.

PRODUCT FEATURES

- Forward/Reflected Meter providing visual indication of measured power for the selected TPM
- Meter Adjustment Pot Provides full scale meter calibration
- Channel Selector selects either one of four (3140A4) connected TPM's
- Zero Calibrate Switch - Grounds pin 9 to Zero calibrate the selected TPM
- DB9 interface connection for power and Zero adjust to connected TPMs and receives TPM output to drive meters

SYSTEM

Operating Voltage	115/230 VAC 50/60 Hz
FWD/RFL Meter	Provides visual indication of measured power for selected TPM
Meter Adj Pot	Provides full scale meter calibration
Channel Selector	Supports up to 4 Transmitter RF Power Monitors
Calibration	Panel Meter can be calibrated independently of the TPMs. There is one user-adjustable pot for each meter.
Power Button	Applies DC input power to panel meter
DB9 Connection	Interface connection to TPM's. Provides power and Zero adjust to connected TPM's. Receives TPM output to drive meters

ENVIRONMENTAL

Operating Temperature	-10 °C to 50 °C (-14 °F to 122 °F)
Storage Temperature	-40 °C to 80 °C (-40 °F to 176 °F)
Humidity	95% ±5% (non-condensing)
Altitude	Up to 10,000 ft (3,048 m)

PHYSICAL

Size	3.5 in x 19 in x 3.5 in (2 RU) (89 mm x 483 mm x 89 mm)
Weight	Approx. 2.5 lb (0.85 kg)

CERTIFICATIONS

Compliance	CE, RoHS
-------------------	----------

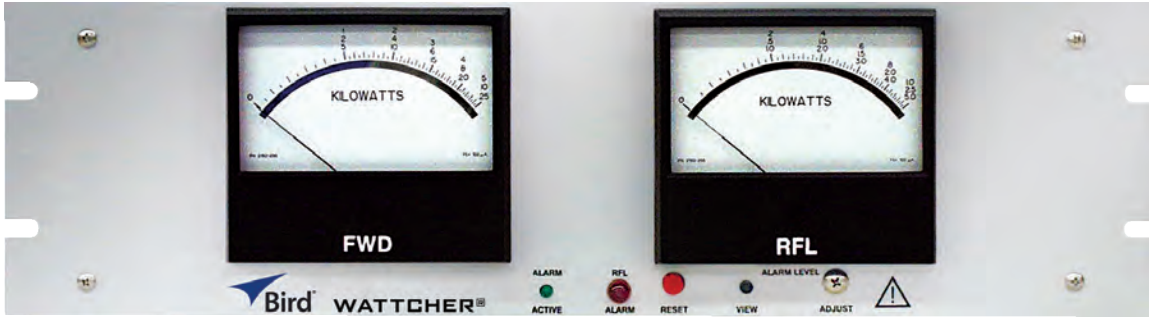

Single Carrier RF Monitors/Alarms

3127A & 3128A SERIES

The 3127A and 3128A Wattcher® RF Power Monitors/Alarms are designed to protect and monitor your RF frequency transmission system by connecting the power meter to a Bird dual port ThruLine® line section and two elements compatible with the RF coaxial line.

The elements are selected by the user to cover the desired power levels and frequency ranges. Remote access is available for resetting audible and visual alarms. Fail-safe or non fail-safe modes are user selectable and the reflected power trip level is adjustable.

	3127A	3128A
Frequency Range	2 MHz to 1 GHz	450 kHz to 2.7 GHz
Power Range	100 W to 250 kW using Bird® Plug-in Elements	100 mW to 10 kW using Bird® Plug-in Elements
Insertion VSWR	N/A	with N connectors 1.05 max to 1000 MHz, 1.1 max to 2700 MHz
Accuracy	±5% of full scale	±5% of full scale
Meter Scales FWD	5, 10, 25 kW	25, 50, 100 W
Meter Scales RFL	1, 2.5, 5 kW	25, 50, 100 W
Meter Sensitivity	100 µA/3000 Ω	30 µA/1400 Ω
Required Products	Line Section: 1 5/8", 3 1/8", 4 1/16", 6 1/8"	Line Section: 4522-002-5 QC Connectors: Two
Elements	Two from Tables 1 5/8 A, 3 1/8 A, 4 1/16 A, or 6 1/8 A	Two from Tables 1, 2, 3, 4, or 6
Accessories	Cable: If length other than 25 ft is desired, order two BNC(M) cables	-

SYSTEM

AC Power	115/230 V, 50/60 Hz @ 0.125 A max
DC Power	9 to 16 V @ 1 A max
Front Control Panel	Reset push-button, reflected power limit display button, adjust alarm level recessed screw
Back Control Panel	FWD/RFL DC signal inputs (BNC), DC power/remote reset connector, DPDT interlock relay connector, fail-safe/nonfail-safe selector, alarm buzzer disable, AC line voltage selector, safety fuses and IEC 320 AC receptacle.
Alarms	Front panel buzzer and red LED
Cable	Includes two 25 ft DC cables

ENVIRONMENTAL

Operating Temperature	-10 °C to 50 °C (-14 °F to 122 °F)
Storage Temperature	-40 °C to 80 °C (-40 °F to 176 °F)
Humidity	95% ±5% (non-condensing)
Altitude	Up to 10,000 ft (3,048 m)

PHYSICAL

Size	5.22 in x 19 in x 3.75 in (133 mm x 483 mm x 95 mm)
Weight	5 lb (2.28 kg)
Finish	Gray powder coat



Dual Element, Single Carrier RF Monitor/Alarm

MODEL 3170B

The dual meter/dual element 3170B Wattcher® RF Monitor and Alarm System can protect your transmitting equipment from damage and loss of air time when faults cause high-standing waves. It can warn a remote operator of low power due to detuning, component deterioration, or AC line difficulties and high reflected power due to factors such as antenna icing, transmission line problems, physical accidents and lightning strikes.

This power monitoring capability is accomplished through the use of a dual-port 50 Ohm insertion-type line section. Each port must contain a standard Bird plug-in element.

3170B	
Power Range	100 mW to 10 kW using Bird® Plug-in Elements
Frequency Range	450 kHz to 2.7 GHz
Insertion VSWR	with N connectors 1.05 max to 1000 MHz, 1.1 max to 2700 MHz
Accuracy	±5% of full scale
Meter Scales FWD/RFL	FWD and RFL 25, 50, 100 W
Meter Sensitivity	100 µA/3000 Ω
Elements	Two from Tables 1, 2, 3, 3A, 4, or 6

SYSTEM

AC Power	115/230 VAC, 50/60 Hz @ 56 mA
DC Power	12.7 to 16.0 VDC @ 400 mA max
Front Control Panel	Reset push-button, adjust FWD/RFL alarm levels screw, element sockets
Back Control Panel	DC FWD/RFL signal inputs, main and remote meter drive outputs, external 12 to 16 VDC supply input, alarm in/out, reset in/out, AC line voltage selector, fuse, IEC 320 AC receptacle.
Alarms	Front Panel Buzzer, "Active" and "Trip" LEDs for forward/reflected
Response Time	25 µs max
Activate Forward	73 µs to 50 ms nominal (adjustable) monitor delay
Calibration Cycle	1 year for element

CONNECTORS

Inputs/Outputs	TTL compatible +5 V logic Outputs for remote meter
Connectors	QC Type (Female N normally supplied)

PHYSICAL

Size	19 in x 5.25 in x 9.3 in (483 mm x 133 mm x 237 mm)
Weight	7 lb (3.2 kg)
Finish	Gray powder coat



RF POWER METERS

Reliability for Test and Measurement in the Field or on the Bench

Bird® designs and builds reliable and superior RF wattmeters and RF line sections whether for harsh conditions or the most challenging situations. Reliability is both a promise and our reality. Bird makes the world's most reliable wattmeters and RF line sections because we have to. No matter the product or its application or its customer, each is made with our single-minded devotion to reliability.



PORTABLE WATTMETERS

Page 62 - 67



PANEL MOUNT WATTMETERS

Page 68 - 69



RIGID LINE SECTIONS

Page 70



FIELD REPLACEMENT METER

Page 71



PLUG-IN ELEMENTS

Page 72 - 77





RF Power Meters

Bird® offers a wide selection of portable insertion-type instruments for measuring forward and reflected power in coaxial transmission lines. ThruLine® instruments can be left in the line for continuous monitoring of the transmitter power output or the amount of RF power reflected by an antenna.



1 TYPES OF POWER METERS

- **Terminating Power Meters** – measures the RF energy that is terminated in a load using either a thermistor, thermocouple, or diode detector. To measure RF power and not damage the RF sensor, a terminating sensor must use an attenuator or directional coupler. This method will introduce mismatch errors which contribute to the overall measurement accuracy.
- **In-line Power Meters** – measures forward and reflected RF energy in a transmission line without disrupting service. Unlike a terminating power meter, the in-line meter is non-intrusive and there is no need for additional equipment to make the measurement. In addition to measuring transmitter power, they can be used to install and maintain wireless base stations, RF generators or repeaters.

2 WHAT ARE ELEMENTS?

Bird wattmeters and other thru-line instruments are based on a “lumped constant” directional coupler. The directional coupler is called an element. Many users also call it a “slug” or a “plug-in”.

Each plug-in element (or coupler) samples the voltage at the point of insertion and samples the current via a loop. Turning the element 180° reverses the loop (and consequently the current pick-up) while the voltage sample remains unchanged. By proper combination of the two parameters, we obtain an RF voltage proportional to the square root of main line RF power. The RF sample is then rectified and a DC signal proportional to the RF envelope is delivered to the meter.

Unlike terminating sensors, Bird elements are carefully designed, manufactured, and calibrated to ensure proper directional RF measurements, without the need for calibration charts or instrument adjustments.

3 BEST PRACTICES

To make an accurate RF power measurement, you need to choose the right wattmeter or sensor and follow these best practices:

Type of Signals – the type of signals to be measured greatly influence the reading. Are you measuring a CW signal or one that has analog or digital modulation? How about a pulsed signal? Make sure the wattmeter or sensor is designed to measure your desired signal.

Eliminate adapters - Best practice for making a RF power measurement is to eliminate or minimize connector adapters. Your power meter may have great directivity, but the reading will be degraded when using many adapters. Use the proper connector to minimize mismatch errors that will impact your RF power reading.

Connectors & Cables – many errors when making an RF power measurement are due to worn connectors or damaged cables. RF measurements depend on the integrity of your cables and connectors used to interconnect the various instruments and devices. Inspect for damage and dirt before connections are made. Metal shavings, bent/cracked center pins can cause poor repeatability and high/variable VSWR.

Directivity – a directional coupler is a key component of every in-line, directional power meter element or “slug”. The directivity parameter, expressed in decibels (dB), is a measure of how well the coupler is capable of distinguishing between the energy traveling towards the load, and the energy that is being reflected due to the load impedance mismatch.



Portable Thru-line Wattmeters

MODEL 43 SERIES, 44 SERIES, & APM-16

The Model 43 Series, Model 44 Series, and APM-16 of Thru-line Directional Wattmeters provide accurate forward and reflected power in 50 Ohm coaxial transmission lines providing instant readings or continuous monitoring. Bird's Plug-in elements determine the power rating and the frequency range so there is no need for calibration charts or instrumentation adjustments. Bird offers a broad selection of portable wattmeters ranging from broadband, fixed, peak, and variable signal measurements.

PRODUCT FEATURES

- Insertion-type instrument designed to measure both forward and reflected CW power in coaxial transmission lines under any load condition.
- Full-scale accuracy of $\pm 5\%$
- QC (quick change) type connectors
- Full range of plug-in elements provide a wide choice of frequency ranges and power levels

BENEFITS

- Measures power as it is being delivered to the load; allows the power meter to be kept in the circuit as the load is active
- Rugged metal housing for the most demanding environments
- Remote installation with removable RF line section
- High directivity and accuracy measurements needed for exceptional system performance



Portable Thruline Wattmeters

MODEL 43 SERIES, 44 SERIES, & APM-16

43 SERIES WATTMETER SELECTION GUIDE

	43	43P	4314C	4304A	4391A
Type	Broadband Wattmeter	Broadband Wattmeter with Peak Power	Broadband Wattmeter with Peak Envelope & Pulsed Power	Single Element Wattmeter	Dual-element Wattmeter
Modulation	CW, AM, FM, and analog TV	CW, AM, FM, SSB and analog TV	CW, AM, FM, SSB, analog TV, and pulsed signals	CW, AM, FM, and analog TV	CW, Pulsed RF (air navigation, DME, ATC, telemetry, radar etc.)
Measurement	Average RF power	Peak pulsed power, average RF power	Peak envelope, peak pulsed, average RF power	Average RF power	Peak envelope, peak pulsed, average RF power
RF Power Range	100 mW to 10 kW (depending on element)	100 mW to 10 kW (depending on element)	100 mW to 10 kW (depending on element)	5 W, 15 W, 50 W, 150 W, 500 W	100 mW to 10 kW (depending on element)
Frequency Range	450 kHz to 1.2 GHz (depending on element)	450 kHz to 1.2 GHz (depending on element)	450 kHz to 1.2 GHz (depending on element)	25 MHz to 1.0 GHz	450 kHz to 1.2 GHz (depending on element)
Power Accuracy	±5% of full scale	CW Mode: ±5% of full scale Peak Mode: ±8% of full scale	CW Mode: ±5% of full scale PEP Mode: ±8% of full scale	±6 to 7% full scale	CW Mode: ±5% of full scale PEP Mode: ±8% of full scale
Pulse Parameters	NA	Pulse width: 200 us min Duty cycle: 2% min Pulse repetition: 100 pps min	Pulse width: 0.4 us min (100 to 2300 MHz), 1.5 us (26 to 99 MHz), 15 us (2 to 25 MHz) Duty cycle: 0.01% min Pulse repetition: 30 pps min	NA	Pulse width: 0.8 us min (100 to 1260 MHz), 1.5 us (26 to 99 MHz), 15 us (2 to 25 MHz) Duty cycle: 0.01% min Pulse repetition: 25 pps min
Connectors	Two Type-N(F) QC	Two Type-N(F) QC	Two Type-N(F) QC	Two Type-N(F) QC Two UHF(F) QC	Two Type-N(F) QC
Elements*	Tables 1, 2, 3, 4, 6, 13, 14	Tables 1, 2, 3, 4, 5, 6	Tables 1, 2, 3, 4, 5, 6, 13, 14	One 4240-050 & one 4304A-1 elements supplied with unit	Tables 1, 2, 3, 4, 5, 6, 13, 14
Power	None required	Two 9 V alkaline	Two 9 V alkaline	None required	AC power cord or six rechargeable C cell batteries

*All Bird® Wattmeters require Bird's Plug-in Elements.

44 SERIES/APM-16 WATTMETER SELECTION GUIDE

	4431	4410A	APM-16
Type	Broadband Wattmeter with Variable RF Sample Port	Wattmeter with Multi-power Level Elements	Wattmeter for Digital Mobile Radio
Modulation	CW, AM, FM, and analog TV	CW or FM signals	CDMA, TDMA, FDMA & other digitally modulated signals
Measurement	Average RF power	Average RF power	Average RF power
RF Power Range	5 kW max (2 to 30 MHz) 1 kW max (30 to 1000 MHz)	100 W, 1000 W or 10,000 W in single plug-in element	1 to 1000 W
Frequency Range	2 MHz to 1.2 GHz	200 kHz to 1.0 GHz	2 MHz to 960 MHz
Power Accuracy	±5% of full scale	±5% of reading	±4% of reading, ±1% of full scale
Pulse Parameters	NA	NA	NA
Connectors	Two Type-N(F) QC	Two Type-N(F) QC	Two Type-N(F) QC
Elements*	Tables 1, 2, 3, 4, 6, 13, 14	4410 elements	APM elements
Power	None required	One 9 V alkaline	One 9 V alkaline

*All Bird® Wattmeters require Bird's Plug-in Elements.



PRODUCT FEATURES

- Temperature-compensated accurate CW and FM power measurements from 200 kHz to 1.0 GHz and 300 mW to 10 kW
- Uses special 4410-series wide-range elements
- Wide-range accuracy over a 37 dB dynamic range and superior temperature performance
- Quick Change (QC) connectors to minimize the need for adapters when making critical measurements

Multipower RF Wattmeters

4410A

The 4410A RF Wattmeter has the basic principles of the Model 43 but transforms it into a highly accurate high dynamic range instrument. The mirrored-scale linear range meter has 2 switchable ranges, 0 to 1 and 0 to 3.

Power is read as a multiple of the value indicated by the pointer, the decimal point location depending upon the range switch position and the factor printed on the plug-in element. Power ranges covered by individual elements are 300 mW to 1 KW and 2 W to 10 KW, full scale. For most elements, accuracy is +/-5% anywhere above 20% of full scale.

ELEMENT SELECTION GUIDE

POWER RANGE	FREQUENCY BANDS (MHz)										
	0.2 to 0.535	0.45 to 2.5	2 to 30	25 to 80	50 to 125	50 to 200	100 to 250	144 to 520	200 to 500	200 to 1000	400 to 1000
0 to 10 W, 30 W, 100 W, 300 W, 1000 W, 3000 W, 10,000 W	4410-1	4410-2	4410-4	—	—	—	—	—	—	—	—
0 to 1 W, 3 W, 10 W, 30 W, 100 W, 1000 W	—	—	4410-3	4410-5	—	4410-6	—	4410-7	—	4410-8	—
0 to 100 mW, 300 mW, 1 W, 3 W, 10 W, 30 W, 100 W	—	—	—	4410-10	4410-11	—	4410-12	—	4410-13	—	4410-14

MEASUREMENT

Power Range	300 mW to 1 kW or 2 W to 10 kW full scale in one single Plug-in Element
Frequency Range	200 kHz to 1.0 GHz CW or FM
Insertion VSWR	With N connectors 1.25 max to 2300 MHz
Accuracy	±5% of reading for any reading above 20% of the Power Range selected for FM or CW signals without AM. This accuracy is maintained for a full 37 dB dynamic range with each 4410 Element (except No. 4410-1 200 kHz to 535 kHz which is accurate to ±10% of reading)
Usable Over Range	To 120% of nominal full scale

CONNECTORS

RF Connectors QC Type (Female N normally supplied)

SYSTEM

Battery Type
4410A 9V Alkaline, included
4412A Rechargeable (see website)
 (i.e. 12 W, 120 W, 1200 W, or 12,000 W). No damage or degradation to the unit will result, regardless of the Range Selector Switch position.

Protection

ENVIRONMENTAL

Ambient Temperature Elements 4410-1 through -8 and -10 through -14 are temperature compensated for rated accuracy from 0 °C to 50 °C (32 °F to 122 °F)

PHYSICAL

Size 6.88 in x 5.13 in x 3.63 in (with connectors)
Weight 3 lb (1.4 kg)
Finish Gray powder coat

OPTIONAL ACCESSORIES

4300A055 Wattmeter, Load, 4 Elements & Accessories Carrying Case
EC-1 12 Plug-In Elements Carrying Case
5-1375 9V, Alkaline Battery

COMPATIBLE ELEMENTS

4410 Elements See selection guide above



PRODUCT FEATURES

- Designed especially for RF power measurement in PCS, cellular, ESMR, paging and similar communication systems
- Equally effective for measuring RF power in conventional analog systems
- Uses APM-series plug-in elements to cover a wide range of frequency and power levels. Simple ThruLine® style operation for instant forward or reflected power readings
- Interchangeable QC connectors for fast hook-up

Average Reading RF Power Meter

APM-16

The APM-16 RF Wattmeter is designed to keep pace with the ever growing complexity of digitally-based communication systems. The APM-16 employs active circuitry to deliver accuracy of $\pm 5\%$ for multiple-access technologies such as CDMA, TDMA, FDMA and other digitally-encoded communication systems.

ELEMENT SELECTION GUIDE

POWER RANGE	FREQUENCY BANDS (MHz)						
	2 to 30	25 to 60	50 to 125	100 to 250	200 to 500	400 to 800	800 to 960
1 W	—	—	APM-1B	APM-1C	—	APM-1E-400	APM-1E-800
2.5 W	—	—	APM-2.5B	—	APM-2.5D	APM-2.5E-400	APM-2.5E-800
5 W	APM-5H	APM-5A	APM-5B	APM-5C	APM-5D	APM-5E-400	APM-5E-800
10 W	APM-10H	APM-10A	APM-10B	APM-10C	APM-10D	APM-10E-400	APM-10E-800
25 W	—	—	APM-25B	APM-25C	APM-25D	APM-25E-400	APM-25E-800
50 W	—	—	—	APM-50C	APM-50D	APM-50E-400	APM-50E-800
100 W	APM-100H	APM-100A	APM-100B	APM-100C	APM-100D	APM-100E-400	APM-100E-800
250 W	APM-250H	APM-250A	APM-250B	APM-250C	APM-250D	APM-250E-400	APM-250E-800
500 W	—	—	APM-500B	APM-500C	APM-500D	APM-500E-400	APM-500E-800
1000 W	APM-1000H	—	APM-1000B	APM-1000C	—	—	—

MEASUREMENT

Power Range	1 W to 1000 W
Frequency Range	2 MHz to 960 MHz
Insertion VSWR	with N Connector 1.05 max to 1000 MHz
Accuracy	10 °C to 35 °C $\pm 4\%$ reading, $\pm 1\%$ full scale -20 °C to 50 °C $\pm 6\%$ reading, $\pm 2\%$ full scale
Peak to Average Ratio	In excess of 10 dB
Setting Time	< 1 second
Meter Scales	Shock mounted, linear scale with expanded scales of 25, 50 and 100 for full scale 1 to 1000 W readings. Mirrored scale includes 5% overrange.

CONNECTORS

RF Connectors	QC Type (Female N normally supplied)
---------------	--------------------------------------

SYSTEM

Battery Type	Internal 9 V, included
--------------	------------------------

ENVIRONMENTAL

Operating Temperature	-20 °C to 50 °C (-4 °F to 122 °F)
Storage Temperature	-25 °C to 65 °C (-13 °F to 149 °F)
Humidity	95% $\pm 5\%$ max (non-condensing)

PHYSICAL

Size	6.88 in x 5.13 in x 3.63 in (175 mm x 130 mm x 92 mm)
Weight	3 lb (1.4 kg)
Finish	Black powder coat

OPTIONAL ACCESSORIES

4300-061	Wattmeter, Load, Signal Sampler, QC Connectors & 4 Elements Carrying Case
CC-6	Wattmeter, 5 Elements and 1 Small Load Carrying Case
EC-1	12 Plug-In Elements Carrying Case
5-1375	9V, Alkaline Battery

COMPATIBLE ELEMENTS

APM Elements See selection guide above



PRODUCT FEATURES

- Frequency: .45 MHz or 45 mW to 2.7 GHz
- Power: 100 mW to 10 kW
- Measures peak or average power flow, load match, and amplitude modulation in 50 Ohm coaxial transmission lines.
- Reads forward and reflected CW or FM power in watts or dBm
- Use with CW, AM, FM, SSB, TV, and Pulse modulation envelopes.
- Calculates SWR, return loss in dB and 5 modulation
- Shock-resistant keyboard and range switches

PEP-Dual Element, RF Power Analyst

4391A

The 4391A is a multi-purpose RF Wattmeter designed around a microcomputer. It will compute VSWR, amplitude modulations, and various decibel variables reducing the odds of error. A program stored in permanent memory controls the operation of the instrument at all times allowing for consistent or repeatable measurements no matter who makes the reading.

Monitors Peak Pulse Power, Peak Envelope Power, or CW Power during normal equipment operations in the forward or reflected direction. Designed for air navigational aids DME, ATC and other pulsed RF systems such as telemetry, radar, command and control, etc.

It needs no attenuators, directional couplers or charts and power range and frequency band are determined by the Plug-in Elements used.

MEASUREMENT

Power Range	100 mW to 10 kW using Bird® Plug-in Elements*
Frequency Range	Built in, 450 kHz to 2.5 GHz
Insertion VSWR	with N connectors 1.05 max to 1000 MHz
Accuracy	Power Readings: CW: ±5% of full scale PEP: ±8% of full scale VSWR: ±10% of reading % Modulation: (CW power 1/3 or more of full scale), ±5% (0-90%), ±10% (90-100%)
Usable Over Range	to 120% of scale (CW, PEP, SWR and Return Loss)
Sampling Rate	2 to 3 readings per second
Modulation	25 to 10,000 Hz (Audio)
Pulse Parameters	Pulse Width: 0.8 μs (100 to 1260 MHz), 1.5 μs (26 to 99 MHz) and 15 μs (2 to 25 MHz); Repetition Rate: 25 PPS; Duty Factor: 1 × 10 ⁻⁴
Return Loss	±0.3 dB to corresponding SWR value

*Quoted accuracy only when used with other Bird® products.

CONNECTORS

RF Connectors QC Type (Female N normally supplied)

SYSTEM

Display	3.5 digit, 0.3 in LED strobed
Battery Type	1.2V, NiMH Rechargeable
Battery Operating Time	8 hours
AC Power Supply	100-130/200-260 V, 50/60 Hz, 6 W

ENVIRONMENTAL

Operating Temperature	10 °C to 45 °C (50 °F to 113 °F)
Storage Temperature	-20 °C to 45 °C (-4 °F to 113 °F)

PHYSICAL

Size (with connectors)	9.56 in x 5.22 in x 4.31 in (243 mm x 158 mm x 110 mm)
Weight	5.75 lb (2.6 kg)
Finish	Blue vinyl with silver anodized side panels

OPTIONAL ACCESSORIES

4300A085	Carrying Case
5A1230	1.2V, NiMH Rechargeable Battery

COMPATIBLE ELEMENTS

4391A Elements	Select two elements in a 10:1 power ratio from Tables 1, 2, 3, 4, 5, 6 and 14
-----------------------	---



PRODUCT FEATURES

- Rigid Line Wattmeters are offered with a choice of meter scales
- Available with or without a forward/reflected power switch
- Scale choices include 15/30/60 kW, 5/10/25 kW and 8/80 kW

Rigid Line Wattmeters

6810 SERIES

The 6810 Series of 100 μ A Rigid Line RF Wattmeters forms a complete power measurement system when combined with the appropriate rigid line section and plug-in elements.

Elements must be ordered according to the desired frequency and power ranges, the meter scales and size of the line section selected for use with the meter.

6810 SERIES	TYPE	SCALES	DC CABLE	USES LINE SECTION
6810-220	4.5 in rectangular meter in housing with FWD and RFL switch	5/10/25 kW	Supplied Cable, 10 ft	Double socket
6810-230	4.5 in rectangular meter in housing with FWD and RFL switch	15/30/60 kW	Supplied Cable, 10 ft	Double socket
6810-250	4.5 in rectangular meter in housing with FWD and RFL switch	8/80 kW	Supplied Cable, 10 ft	Double socket
6810-265	4.5 in rectangular meter in housing	8/80 kW	Supplied Cable, 10 ft	Single socket
6810-307	4.5 in rectangular meter in housing	15/30/60 kW	Supplied Cable, 10 ft	Single socket
6810-309-7	4.5 in rectangular meter in housing	5/10/25 kW	Supplied Cable, 10 ft	Single socket

SINGLE SOCKET RIGID LINE SECTION

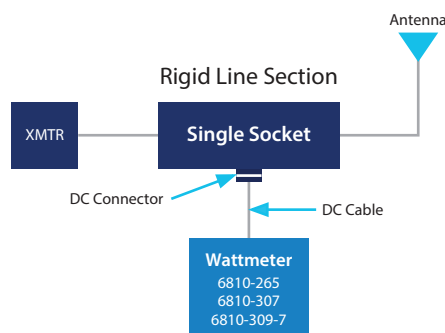

DUAL SOCKET RIGID LINE SECTION

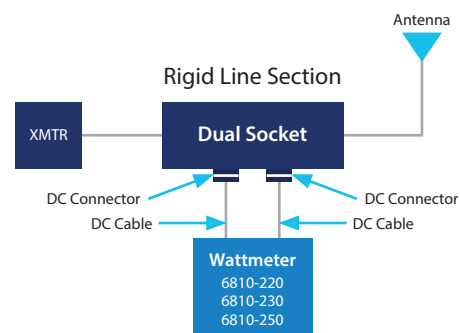



Rigid Line Wattmeters

3127 SERIES

The 3127 Series of 100 μ A Rigid Line RF Wattmeters forms a complete power measurement system when combined with the appropriate rigid line section and plug-in elements.

Elements must be ordered according to the desired frequency and power ranges, the meter scales and size of the line section selected for use with the meter.

3127 SERIES	TYPE	SCALES	DC CABLE	USES LINE SECTION
3127-040	Dual 4.5 in rectangular meter on panel	5/10/25 kW	4220-097-10- RF Coaxial Cable. 25 ft	Double socket
3127-075	Dual 4.5 in rectangular meter on panel	15/30/60 kW	4220-097-10- RF Coaxial Cable. 25 ft	Double socket

PHYSICAL

Size (with connectors)	19 in x 5.22 in x 4.38 in (483 mm x 132.6 mm x 111.25mm)
Weight	4 lb (1.8 kg)
Finish	Gray

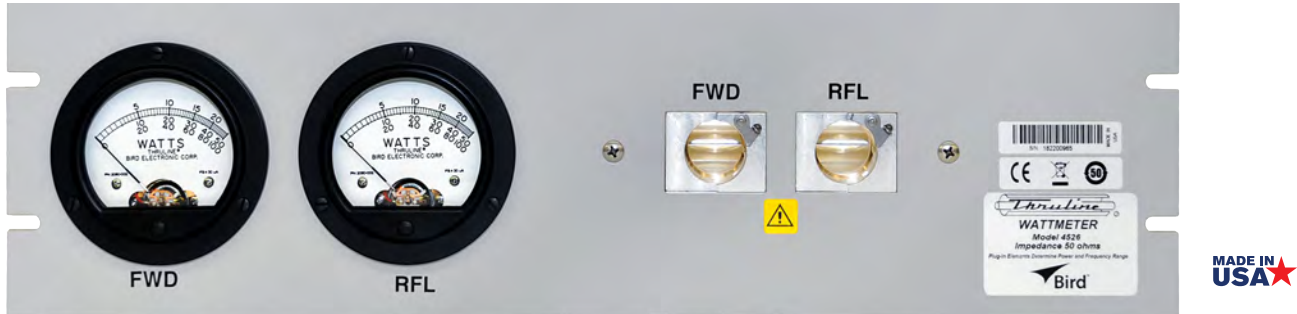

Dual Meter, Dual Element, Panel-Mount RF Wattmeters

MODELS 4526 & 4527

The Model 4526 & 4527 panel-mount RF Wattmeters have both dual-meter and dual-element sockets. These features let you determine VSWR more precisely using a more sensitive reflected power element and simultaneously read forward and reflected power. The panel mount styles are versions of our legacy tested Model 43 and are used in rack installation. The 4527 has an RF sampler that provides a low power sample of the main RF signal. The sampler output may be fed to any RF signal suitable monitoring device, e.g., a frequency counter, spectrum analyzer, or oscilloscope. Consult with the factory for appropriate combined transmitter monitoring products.

	4526	4527
Frequency Range	450 kHz to 2.7 GHz (depending on element)	2 to 512 MHz (depending on element)
Insertion VSWR	With N Connectors 1.05 max to 1000 MHz	With N Connectors 1.05 max to 512 MHz
RF Sample Output	N/A	Fixed at -53 dB from 512 to 10 MHz decreasing to -70 dB at 2 MHz BNC(F) port
Elements	Tables 1, 2, 3, 4, 6	2 to 512 MHz models within Tables 1, 2, 6

*Quoted accuracy only when used with other Bird® Products.

MEASUREMENT

Power Range	100 mW to 10 kW using Bird Plug-in Elements (applies only when coupling is less than 30 dB)
Accuracy	±5% of full scale

*Quoted accuracy only when used with other Bird® Products.

CONNECTORS

RF Connectors	QC Type (Female N normally supplied)
----------------------	--------------------------------------

PHYSICAL

Size	5.22 in x 19 in x 1.69 in (with connectors) (133 mm x 483 mm x 43 mm)
Weight	3.5 lb (1.6 kg)
Finish	Gray powder coat

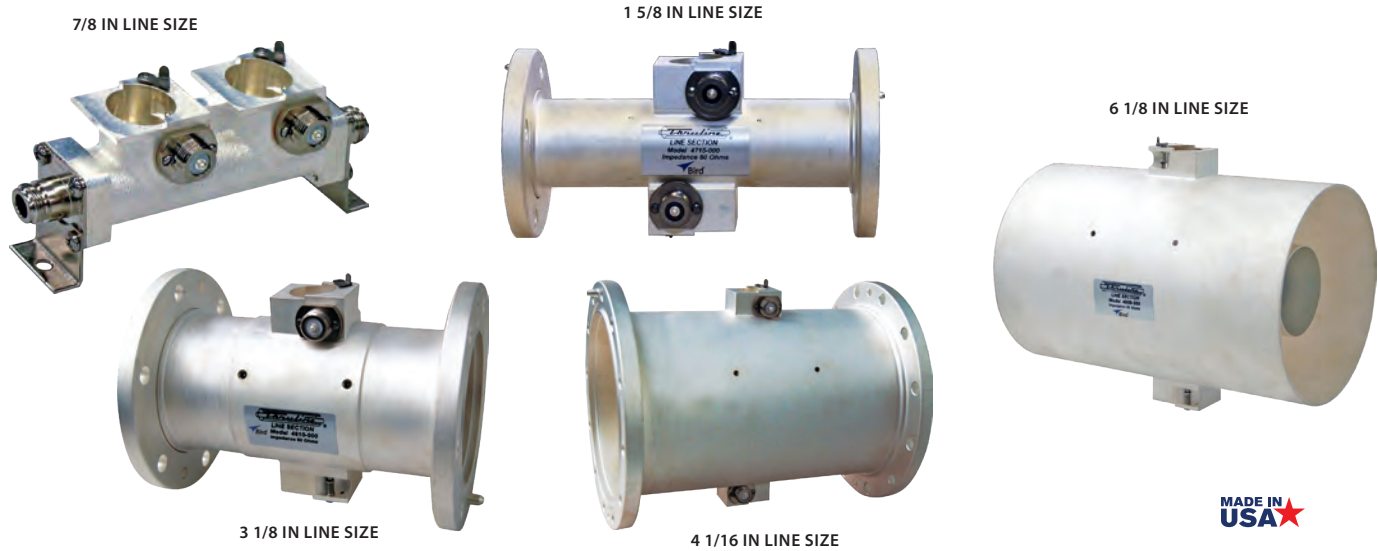

Rigid Line Sections

THRULINE® WATTMETER COMPONENTS

Bird manufactures 50 Ohm 7/8 in, 1-5/8 in, 3-1/8 in, 4-1/16, and 6-1/8 in RF Line Sections. Each line section is equipped with one or two sockets where Plug-In Elements, in the desired power and frequency range, are inserted. Double-socket line sections are for simultaneous measurement of forward and reflected power. Designed for insertion between a RF transmitter and antenna or load.

LINE SECTION SELECTION GUIDE

7/8 inch	RF CONNECTOR	ELEMENT SOCKETS	LINE SIZE	LENGTH	WEIGHT
4230-006-1	QC (not included)	1	7/8 in	4 in	1 lb
4230-018	N-Type(F)	1	7/8 in	5.5 in	1.33 lb
4230-057	N-Type(F)	1 w/ Bracket	7/8 in	5.13 in	1.34 lb
4230-059	QC (not included)	1 w/ Bracket	7/8 in	4 in	1.25 lb
4522A002-5	QC (not included)	2 - Panel Mount	7/8 in	6.22 in	1.25 lb
1-5/8 inch	CONNECTOR TYPE	ELEMENT SOCKETS	LINE SIZE	LENGTH	WEIGHT
4715-000	EIA Flanged	2	1-5/8 in	6.75 in	3.25 lb
4723-000	Unflanged (Rec. 0.438 in)	2	1-5/8 in	6.38 in	1.5 lb
4723-020	Unflanged (Flush)	2	1-5/8 in	6.38 in	1.5 lb
3-1/8 inch	CONNECTOR TYPE	ELEMENT SOCKETS	LINE SIZE	LENGTH	WEIGHT
4610-000	EIA Flanged	2	3-1/8 in	7.03 in	7.25 lb
4801-100	Unflanged (Rec. 0.688 in)	2	3-1/8 in	6.5 in	4.25 lb
4802-000	Unflanged (Flush)	2	3-1/8 in	6.5 in	4.25 lb
4-1/16 inch	CONNECTOR TYPE	ELEMENT SOCKETS	LINE SIZE	LENGTH	WEIGHT
4642-010	Flanged (MYAT)	2	4-1/16 in	8.13 in	8.88 lb
6-1/8 inch	CONNECTOR TYPE	ELEMENT SOCKETS	LINE SIZE	LENGTH	WEIGHT
4905-000	EIA Flanged	2	6-1/8 in	10.22 in	17 lb
4909-000	Unflanged (Rec. 0.968 in)	2	6-1/8 in	9.63 in	12.75 lb

Field Replacement Meter Movement Assembly Kit

RPK43-4

The RPK43-4 is a complete replacement assembly kit for use with the Bird Model 43 Series of RF Wattmeters. This kit includes a 3.5 in round meter face, coaxial meter cable, shock ring, neoprene gasket -and shorting plug.

	RPK43-4
Description	3.5 in round replacement meter movement assembly kit
Current	30 μ A/1400 Ohms
Meter Scales	25/50/100 W
Elements	Tables 1, 2, 3, 4, 6
Compatible with	Bird Wattmeter models: 43, 43P, 4431, 4521, 4522, 4526 and 4527

RF Wattmeter Movement Kit

4210A100

For custom applications and builds, the 4210A100 is a complete kit with a square meter pre-mounted in an aluminum housing. When combined with the appropriate 7/8 inch line section, QC connectors and elements you can assemble to a custom rack mount or use as a benchtop wattmeter.

	4210A100
Description	3.25 in square Wattmeter movement kit in aluminum housing
Current	30 μ A/1400 Ohms
Meter Scales	25/50/100 W
Elements	Tables 1, 2, 3, 4, 6

Replacement Meter Movement Face

RPK2080-002

The RPK2080-002 is a replacement meter face for use with the Bird Model 43 Series of RF Wattmeters.

	RPK2080-002
Description	3.5 in round replacement meter face movement assembly
Current	30 μ A/1400 Ohms
Meter Scales	25/50/100 W
Elements	Tables 1, 2, 3, 4, 6
Compatible with	Bird Wattmeter models: 43, 43P, 4431, 4521, 4522, 4526 and 4527



MADE IN
USA



MADE IN
USA



MADE IN
USA



ELEMENT SELECTION GUIDE

MODEL	TABLE(S)	MODEL	TABLE(S)
3128A	1, 2, 3, 4, 6, 13, 14	4391A	1, 2, 3, 4, 5, 6, 13, 14
3170B	1, 2, 3, 4, 6, 13, 14	4410A, 4412A	13
43	1, 2, 3, 4, 6, 13, 14	4431	1, 2, 3, 4, 6, 13, 14
43P	1, 2, 3, 4, 5, 6, 13	4526	1, 2, 3, 4, 6, 13, 14
4314C	1, 2, 3, 4, 5, 6, 13, 14	4527	2 MHz to 512 MHz elements in 1, 2, 6, 13, 14

Plug-In Elements

FOR 7/8 IN LINE SECTIONS & WATTMETERS

All Bird Plug-In Elements are calibrated in accordance with meticulous Bird calibration procedures supported by a long history of mean deviation values to assure adherence to advertised specifications of current instruments, as well as field interchangeability with equipment purchased, used and trusted in all the years since its introduction.

TABLE 1 STANDARD ELEMENTS

POWER RANGE	FREQUENCY BANDS (MHz)						
	2 to 30	25 to 60	50 to 125	100 to 250	200 to 500	400 to 800	800 to 1000
5 W	—	5A	5B	5C	5D	5E-400	5E-800
10 W	—	10A	10B	10C	10D	10E-400	10E-800
25 W	25H	25A	25B	25C	25D	25E-400	25E-800
50 W	50H	50A	50B	50C	50D	50E-400	50E-800
100 W	100H	100A	100B	100C	100D	100E-400	100E-800
250 W	250H	250A	250B	250C	250D	250E-400	250E-800
500 W	500H	500A	500B	500C	500D	500E-400	500E-800
1000 W	1000H	1000A	1000B	1000C	1000D	1000E-400	1000E-800
2500 W	2500H	2500A	2500B	2500C	2500D	2500E-400	2500E-800
5000 W	5000H	5000A	5000B	5000C	5000D	5000E-400	5000E-800

TABLE 2 LOW-POWER ELEMENTS

POWER RANGE	FREQUENCY BANDS (MHz)										
	40 to 50	50 to 60	60 to 80	80 to 90	95 to 125	110 to 160	150 to 250	200 to 300	275 to 450	425 to 850	800 to 1000
1 W	040-1	050-1	060-1	080-1	095-1	110-1	150-1	200-1	275-1	425-1	801-1

POWER RANGE	FREQUENCY BANDS (MHz)											
	25 to 30	30 to 40	40 to 50	50 to 60	60 to 80	80 to 95	95 to 150	150 to 250	200 to 300	250 to 450	400 to 850	800 to 1000
2.5 W	025-2	030-2	040-2	050-2	060-2	080-2	095-2	150-2	200-2	250-2	400-2	801-2



ELEMENT SELECTION GUIDE

MODEL	TABLE(S)	MODEL	TABLE(S)
3128A	1, 2, 3, 4, 6, 13, 14	4391A	1, 2, 3, 4, 5, 6, 13, 14
3170B	1, 2, 3, 4, 6, 13, 14	4410A, 4412A	13
43	1, 2, 3, 4, 6, 13, 14	4431	1, 2, 3, 4, 6, 13, 14
43P	1, 2, 3, 4, 5, 6, 13	4526	1, 2, 3, 4, 6, 13, 14
4314C	1, 2, 3, 4, 5, 6, 13, 14	4527	2 MHz to 512 MHz elements in 1, 2, 6, 13, 14

Plug-In Elements

FOR 7/8 IN LINE SECTIONS & WATTMETERS

TABLE 3 HIGH-FREQUENCY ELEMENTS, ACCURACY $\pm 8\%$ OF FULL SCALE

POWER RANGE	FREQUENCY BANDS (MHz)	
	950 to 1100	1100 to 1260
1 W	1J-950	1J-1100
2.5 W	2.5J-950	2.5J-1100
5 W	5J-950	5J-1100
10 W	10J-950	10J-1100
25 W	25J-950	25J-1100
50 W	50J-950	50J-1100
100 W	100J-950	100J-1100
250 W	250J-950	250J-1100
500 W	500J-950	500J-1100
1000 W	1000J-950	1000J-1100
2500 W	2500J-950	2500J-1100
5000 W	5000J-950	5000J-1100

TABLE 4 LOW-FREQUENCY ELEMENTS

POWER RANGE	FREQUENCY BANDS (MHz)
	.45 to 2.5
1000 W	1000P
2500 W	2500P
5000 W	5000P
10000 W	10000P



MADE IN USA

ELEMENT SELECTION GUIDE

MODEL	TABLE(S)	MODEL	TABLE(S)
3128A	1, 2, 3, 4, 6, 13, 14	4391A	1, 2, 3, 4, 5, 6, 13, 14
3170B	1, 2, 3, 4, 6, 13, 14	4410A, 4412A	13
43	1, 2, 3, 4, 6, 13, 14	4431	1, 2, 3, 4, 6, 13, 14
43P	1, 2, 3, 4, 5, 6, 13	4526	1, 2, 3, 4, 6, 13, 14
4314C	1, 2, 3, 4, 5, 6, 13, 14	4527	2 MHz to 512 MHz elements in 1, 2, 6, 13, 14

Plug-In Elements

FOR 7/8 IN LINE SECTIONS & WATTMETERS

TABLE 5 PULSE-POWER ELEMENTS, (PEAK ONLY) ±8% OF FULL SCALE

POWER RANGE	FREQUENCY BANDS (MHz)					
	2 to 30	25 to 60	50 to 125	100 to 250	400 to 800	800 to 1000
500 W	—	—	—	—	—	—
1000 W	—	—	—	—	—	—
2500 W	—	2500A	2500B	2500C	2500E-400	2500E-800
5000 W	—	5000A	5000B	5000C	5000E-400	5000E-800
10000 W	10000H	—	10000B	—	10000E-400	10000E-800

Refer to "Transmission Power Rating Chart" for max power ratings. Elements are capable of reading peak and average power.

TABLE 6 MILLIWATT ELEMENTS

POWER RANGE	FREQUENCY BANDS (MHz)									
	40 to 50	72 to 76	108 to 136	135 to 175	320 to 340	328 to 336	400 to 420	420 to 450	450 to 470	800 to 1000
100 mW	—	430-2	430-57	430-86	430-205	430-3	430-7	430-208	430-8	430-263

POWER RANGE	FREQUENCY BANDS (MHz)								
	72 to 76	88 to 108	105 to 120	116 to 126	130 to 150	190 to 210	329 to 336	450 to 470	800 to 1000
250 mW	430-22	430-217	430-20	430-48	430-13	430-65	430-16	430-61	430-264

POWER RANGE	FREQUENCY BANDS (MHz)													
	72 to 76	88 to 108	105 to 120	120 to 136	136 to 150	240 to 290	290 to 340	329 to 336	340 to 360	350 to 400	400 to 450	450 to 500	600 to 800	800 to 1000
500 mW	430-33	430-247	430-26	430-248	430-249	430-27	430-253	430-28	430-157	430-254	430-255	430-256	430-258	430-265

TABLE 13 NONDIRECTIONAL SAMPLER ELEMENTS FOR QC-TYPE OR 7/8 IN EIA LINE

MODEL	FREQUENCY BAND (MHz)	NOMINAL COUPLING	MAX MAIN LINE POWER
4274-025	25 to 1000	-50 dB ±2 dB (-66 dB @ 2 MHz)	500 W
4274-050	100 to 400	-35 to -48 dB (±1 dB) Adjustable)	500 W



MADE IN USA

ELEMENT SELECTION GUIDE

MODEL	TABLE(S)	MODEL	TABLE(S)
3128A	1, 2, 3, 4, 6, 13, 14	4391A	1, 2, 3, 4, 5, 6, 13, 14
3170B	1, 2, 3, 4, 6, 13, 14	4410A, 4412A	13
43	1, 2, 3, 4, 6, 13, 14	4431	1, 2, 3, 4, 6, 13, 14
43P	1, 2, 3, 4, 5, 6, 13	4526	1, 2, 3, 4, 6, 13, 14
4314C	1, 2, 3, 4, 5, 6, 13, 14	4527	2 MHz to 512 MHz elements in 1, 2, 6, 13, 14

Directional Coupler Elements

FOR RIGID LINE SECTIONS & WATTMETERS

Coupler elements used for RF sampling. The wattmeter display does not read when these elements are installed.

TABLE 14 DIRECTIONAL COUPLER ELEMENTS FOR QC-TYPE OR 7/8 IN EIA LINE

MODEL	FREQUENCY BAND (MHz)	NOMINAL COUPLING	MAX MAIN LINE POWER
400-50	50 to 100	-40 dB	-
400-75	75 to 150	-40 dB	-
400-125	125 to 250	-40 dB	1 kW
400-225	225 to 450	-40 dB	1 kW
400-400	400 to 800	-40 dB	1 kW
400-750	750 to 1250	-40 dB	1 kW

TABLE 15 DIRECTIONAL COUPLER ELEMENTS FOR 1 5/8 IN EIA LINE

MODEL	FREQUENCY BAND (MHz)	NOMINAL COUPLING	MAX MAIN LINE POWER
501-50	50 to 100	-50 dB	10 kW
501-75	75 to 150	-50 dB	10 kW
501-125	125 to 250	-50 dB	10 kW
501-225	225 to 450	-50 dB	10 kW
501-400	400 to 800	-50 dB	5 kW

NOTE: For use in any line section including BPME

TABLE 16 DIRECTIONAL COUPLER ELEMENTS FOR 3 1/8 IN EIA LINE

MODEL	FREQUENCY BAND (MHz)	NOMINAL COUPLING	MAX MAIN LINE POWER
553-50	50 to 100	-55 dB	25 kW
553-75	75 to 150	-55 dB	25 kW
553-125	125 to 250	-55 dB	25 kW
553-401	400 to 800	-55 dB	15 kW

TABLE 17 DIRECTIONAL COUPLER ELEMENTS FOR 6 1/8 IN EIA LINE

MODEL	FREQUENCY BAND (MHz)	NOMINAL COUPLING	MAX MAIN LINE POWER
606-50	50 to 100	-60 dB	60 kW
606-400	400 to 870	-60 dB	60 kW



ELEMENT SELECTION GUIDE

MODEL	TABLE(S)
3127A	1 5/8 A, 3 1/8 A
3127-040	1 5/8 A, 3 1/8 A, 4 1/16 A
3127-075	1 5/8 B
6810-220	1 5/8 A, 3 1/8 A
6810-230	1 5/8 B

**Plug-In Elements
FOR RIGID LINE SECTIONS**

TABLE 1 5/8 A STANDARD ELEMENTS 100 μA

POWER RANGE	FREQUENCY BANDS (MHz)		
	2 to 30	50 to 125	100 to 250
100 W	—	100B1	100C1
250 W	—	250B1	250C1
500 W	—	500B1	500C1
1000 W	1000H1	1000B1	1000C1
2500 W	2500H1	2500B1	2500C1
5000 W	5000H1	5000B1	5000C1
10 kW	10KH1	10KB1	10KC1
25 kW	25KH1	25KB1	—

TABLE 1 5/8 AA STANDARD ELEMENTS 30 μA

POWER RANGE	FREQUENCY BANDS (MHz)		
	2 to 30	50 to 125	100 to 250
100 W	—	100B12	100C12
250 W	—	250B12	250C12
500 W	500H12	500B12	—
1000 W	1000H12	1000B12	1000C12
2500 W	2500H12	2500B12	2500C12
5000 W	5000H12	5000B12	—
10 kW	10KH12	10KB12	—
25 kW	25KH12	—	—

TABLE 1 5/8 B STANDARD ELEMENTS 100 μA

POWER RANGE	FREQUENCY BANDS (MHz)	
	2 to 30	50 to 125
300 W	—	300B1
600 W	—	600B1
1500 W	1500H1	1500B1
3000 W	3000H1	3000B1
6000 W	6000H1	6000B1
15 kW	15KH1	15KB1
50 kW	50KH1	—



ELEMENT SELECTION GUIDE

MODEL	TABLE(S)
3127A	1 5/8 A, 3 1/8 A
3127-040	1 5/8 A, 3 1/8 A, 4 1/16 A
3127-075	1 5/8 B
6810-220	1 5/8 A, 3 1/8 A
6810-230	1 5/8 B

Plug-In Elements

FOR RIGID LINE SECTIONS

TABLE 3 1/8 A STANDARD ELEMENTS 100 μ A

POWER RANGE	FREQUENCY BANDS (MHz)		
	2 to 30	50 to 125	100 to 250
100 W	—	100B3	—
250 W	—	250B3	250C3
500 W	—	500B3	500C3
1000 W	—	1000B3	1000C3
2500 W	2500H3	2500B3	2500C3
5000 W	5000H3	5000B3	5000C3
1.5 kW	—	1500B3	—
10 kW	10KH3	10KB3	10KC3
15 kW	—	15KB3	—
25 kW	25KH3	25KB3	25KC3
50 kW	50KH3	50KB3	—
100 kW	100KH3	—	—

RF LOADS & ATTENUATORS

Rugged and Reliable Solutions for Low to High Power Attenuation and Termination



MADE IN USA ★

CONDUCTION-COOLED LOADS

Page 83



CONVECTION-COOLED LOADS

Page 84 - 85



MADE IN USA ★

OIL-COOLED LOADS

Page 86 - 87



MADE IN USA ★

MARKET SPECIFIC LOADS

Page 88



MADE IN USA ★

WATER-COOLED LOADS

Page 89



MADE IN USA ★

DIGITAL AIR-COOLED LOADS

Page 90 - 91



MADE IN USA ★

MODULOADS

Page 92



MADE IN USA ★

OIL CONVECTION-COOLED
ATTENUATORS

Page 93



CONVECTION-COOLED
ATTENUATORS

Page 94 - 95



Attenuators

Bird manufactures a broad spectrum of RF power attenuators from 2 W to 4000W. Our resistive product portfolio includes air-cooled, water-cooled, oil-dielectric, convection cooled, and conduction cooled RF units.

1 WHAT IS AN ATTENUATOR?

Bird's Convection cooled RF Attenuators are components that will reduce the amplitude level of an incoming signal and are used to protect systems from receiving a signal with a power level that is too high to process. Attenuators are a valuable and reliable accessory for reducing power levels, for isolating components under test, for harmonic signal analysis, and as comparison standards. Convection RF Attenuators feature a self-cooling design, frequencies up to 18GHz and fully shielded.

2 ATTENUATOR SELECTION CRITERIA

- **Attenuation Value** - most important of all is attenuation factor. Attenuators are available from 0 dB to 40 dB and above depending on applications. Attenuation is how much power is removed from the signal before the output.
- **Power Rating (Watts)** - it is recommended to pick one with higher power handling capability than your required power
- **Convection Product Type**
 1. **A** = input and output connector on the same side of the heatsink
 2. **SA and WA** = connectors in-line, or straight through the heatsink
- **Connector Gender** - Male or Female combinations
- **Connector Type** - SMA, BNC, N, TNC or IEC 7/16





RF Loads

Bird manufactures a broad spectrum of devices from one watt to eighty kilowatts. Our resistive product portfolio includes air-cooled, water-cooled, oil-dielectric, convection cooled, and conduction cooled RF attenuators and RF loads.

1 WHAT IS A RF LOAD?

RF Loads come in various shapes and sizes and provide one purpose – convert RF electrical energy into a form of energy that can be dissipated efficiently, economically, and safely. The purpose of a load or termination (also known as a “dummy load”) is to absorb RF energy and turn it into heat. Many times, the load takes the place of an antenna during transmitter testing.

2 OTHER APPLICATIONS WHERE TERMINATIONS CAN BE FOUND

- Reject Loads
- Hybrid Combiners
- Isolators / Circulators
- Transmitter Tuning
- System Testing & Calibration

3 CONSIDERATION BASICS

Terminations should be properly matched to the characteristic impedance of a transmission line. The termination characteristics of primary concern are operating frequency range, average power handling capability, operating temperature range, VSWR, size and weight. Impedance is typically 50 Ohms unless otherwise stated.

▪ Electrical Considerations

1. **Frequency Range** - the exact operating frequency range of each dummy load should be specified
2. **Maximum VSWR** - measure of how well the load is “matched” to the transmission line
3. **Peak to Average Power Ratio** - how much “Instantaneous” power can be absorbed
4. **Power Rating** - the amount of energy (heat) a load can absorb. The average and peak powers are interrelated in that the peak power capacity is a function of the operating temperature which in turn is a function of the average power. These are then impacted by the ambient temperature of the cooling medium (air or water).

▪ Mechanical considerations - Connectors or Flanges, Dimensions, mounting provisions, Coolant

▪ Environmental Consideration - Ambient Temperature Range, Coolant Flow, Coolant Temp, Humidity, Shock, Vibration and Altitude

4 WHAT ARE THE TYPES OF LOADS?

Load types are defined by cooling methods: Convection, Conduction, Oil Cooled, Water Cooled and Forced air (Moduloads). Bird offers power levels from 2 W to 80 kW.



- Convection cooling** describes a termination equipped with a heat sink with cooling fins. A heat sink with cooling fins increases the effective heat exchange toward the environment. The heat sink is characterized by its thermal resistance or by the increase of surface temperature per watt (in °C per W). The shorter this value is, the greater the power will be.



- Conduction cooling** describes the termination heat transfer by means of molecular agitation within the material without any motion of the material as a whole, this is considered a passive cooling device. Important considerations are ambient temperature and how much free airflow is available and the amount of heat needed to dissipate.



- Water-cooled loads** use pressurized water of proper temperature and flow rate to carry heat away from the resistive element. The water-cooling system can be sub-divided into two groups: water that is contained totally inside the resistor and water that flows on both the inside and outside of the resistor. Advantages include superior efficiency, small size and common for calorimetry due to containment of heat flux paths. Typical mixtures are 50/50 water/glycol mixture or potable water.



- Moduload** is for those installations that do not have water access or good water quality but still desire high power capabilities, Bird manufactures a water-cooled load (Moduload series) that is completely self-contained.



- Oil-dielectric loads** surround the resistive element with oil, which transfers heat to an exterior, finned shell for dissipation into the surrounding air.



- Air-cooled loads** use the properties of moving air to transfer the heat away from the resistive element. Typically, these loads are equipped with fans to move the air past the resistors. They are virtually maintenance free, handle extremely high peak powers and high operating temperatures. They do have a large footprint which also limits the frequency.

Typical Peak Power Ratings For Bird Loads

Understanding your application and criteria for the heat sink when using a conductive load for proper operation will assure your needs are met in thermal performance and will help eliminate any unwanted effects in the entire system.

OIL-COOLED LOADS

MODEL	AVERAGE POWER	PULSE WIDTH (MICROSECONDS)					FREQUENCY RANGE	VSWR
		1 μ	10 μ	100 μ	1000 μ	5000 μ		
8135	150 W	10 kW	8 kW	5.75 kW	3.5 kW	2 kW	DC to 1 GHz 1 to 2.5 GHz 2 to 4 GHz	1.1:1 1.2:1 1.3:1
8201	500 W	200 kW	150 kW	105 kW	57 kW	25 kW	DC to 1 GHz 1 to 2.5 GHz	1.1:1 1.25:1
8251	1 kW	200 kW	150 kW	105 kW	57 kW	25 kW	DC to 1 GHz 1 to 2 GHz 2 to 2.4 GHz	1.1:1 1.25:1 1.3:1
8890 Series	2.5 kW	150 kW	115 kW	80 kW	54 kW	22 kW	DC to 1 GHz 1 to 2 GHz 2 to 2.4 GHz	1.1:1 1.25:1 1.3:1
8920 Series	5 kW	150 kW	115 kW	80 kW	54 kW	22 kW	DC to 1 GHz	1.1:1
8930 Series	10 kW	150 kW	120 kW	85 kW	55 kW	30 kW	DC to 400 MHz 400 MHz to 1 GHz	1.15:1 1.2:1

Note: Duty factor should be such that the average power rating of the load is never exceeded.

WATER-COOLED LOADS

MODEL	AVERAGE POWER	PULSE WIDTH (MICROSECONDS)					FREQUENCY RANGE	VSWR
		1 μ	10 μ	100 μ	1000 μ	5000 μ		
8730 Series	10 kW	100 kW	77 kW	50 kW	32 kW	16 kW	DC to 1 GHz	1.1:1
8740 Series	20 kW	250 kW	190 kW	135 kW	75 kW	35 kW	1 kHz to 900 MHz	1.1:1
8750 Series	30 kW	250 kW	190 kW	135 kW	75 kW	40 kW	1 kHz to 900 MHz	1.1:1
8760 Series	40 kW	250 kW	197 kW	145 kW	90 kW	55 kW	1 kHz to 900 MHz	1.1:1
8770 Series	50 kW	250 kW	197 kW	145 kW	97 kW	65 kW	1 kHz to 900 MHz	1.1:1
8790 Series	80 kW	250 kW	210 kW	170 kW	130 kW	100 kW	1 kHz to 900 MHz	1.15:1

Note: Duty factor should be such that the average power rating of the load is never exceeded.





RF Power Loads

CONDUCTION-COOLED

Dry Conduction-Cooled RF Power Loads are world-renowned for their high-quality, robust construction and conservative power ratings. The use of non-magnetic materials and plating provide safety when used in applications with high magnetic fields such as MRI.

LOAD CONFIGURATION GUIDE

POWER RATING	PRODUCT TYPE	CONNECTOR GENDER	CONNECTORS*
See selection guide	T, WT = Convection-cooled CT = Conduction-cooled ST = Square convection-cooled	F = Female M = Male	A = SMA B = BNC N = N T = TNC E = IEC 7/16

*Call for custom connector options not shown in this catalog

Example: 25-CT-FB= Model 25-CT, 25 W, conduction-cooled load with female BNC connectors.

Note: Not all combinations are valid. If assistance is needed consult the factory to define the model that is right for you.

LOAD SELECTION GUIDE

MODEL	POWER RATING	CONNECTORS	FREQUENCY RANGE & VSWR	DIMENSIONS	WEIGHT
25-CT	25 W	SMA	DC to 1 GHz @ 1.15:1 max 1 to 3 GHz @ 1.25:1 max	0.9 in x 1.0 in x 0.5 in (23 x 26 x 13 mm)	0.4 oz (12 g)
50-CT	50 W	SMA	DC to 3 GHz @ 1.15:1 max 3 to 6 GHz @ 1.25:1 max	0.8 in x 0.9 in x 0.4 in (21 x 23 x 11 mm)	1.1 oz (32 g)
100-CT	100 W	SMA	DC to 2 GHz @ 1.15:1 max 2 to 3 GHz @ 1.25:1 max	1.4 in x 1.4 in x 0.6 in (36 x 36 x 16 mm)	1.0 oz (30 g)
150-CT	150 W	N	DC to 2 GHz @ 1.15:1 max 2 to 3 GHz @ 1.25:1 max	1.9 in x 1.2 in x 1.1 in (49 x 31 x 28 mm)	2.2 oz (63 g)
150-CT	150 W	SMA	DC to 2 GHz @ 1.15:1 max 2 to 3 GHz @ 1.25:1 max	2.1 in x 2.1 in x 0.6 in (54 x 54 x 16 mm)	2.2 oz (63 g)
151-CT	150 W	N	DC to 1 GHz @ 1.10:1 max 1 to 4 GHz @ 1.25:1 max	2.0 in x 2.0 in x 1.1 in (51 x 51 x 28 mm)	2.2 oz (63 g)
250-CT	250 W	BNC, N	DC to 1 GHz @ 1.10:1 max 1 to 2.4 GHz @ 1.25:1 max	2.5 in x 2.2 in x 1.1 in (64 x 56 x 28 mm)	5.2 oz (148 g)
250-CT	250 W	SMA	DC to 2 GHz @ 1.15:1 max 2 to 3 GHz @ 1.25:1 max	2.1 in x 2.1 in x 0.6 in (54 x 54 x 16 mm)	5.2 oz (148 g)
300-CT	300 W	N	DC to 1 GHz @ 1.10:1 max 1 to 3 GHz @ 1.25:1 max	4.8 in x 2.0 in x 1.2 in (122 x 51 x 31 mm)	12 oz (340 g)
500-CT	500 W	SMA, BNC, N, TNC	DC to 1 GHz @ 1.15:1 max 1 to 3 GHz @ 1.30:1 max	2.7 in x 2.0 in x 1.2 in (69 x 51 x 31 mm)	8.2 oz (233 g)

PRODUCT FEATURES

- Ultra-compact, lightweight design
- Economical design
- Fully shielded against production of extraneous radiation
- Load requires no AC power
- Requires a heatsink capable of maintaining a case temperature at or below 100°C

SYSTEM

Coolant Method	Dry, conduction-cooled
Impedance	50 Ohms
AC Power	None
Finish	Tri-alloy
Operating Position	Any

ENVIRONMENTAL

Water Inlet Temperature	-40 °C to 40 °C (-40 °F to 104 °F)
--------------------------------	------------------------------------



RF Power Loads CONVECTION-COOLED

Bird manufactures a broad line of Convection-Cooled RF Loads. They are known for their high-quality, rugged construction and conservative power ratings. These loads are fully shielded against production of extraneous radiation and the self-cooling design needs no cooling plate.

PRODUCT FEATURES

- Self-cooling design, needs no cooling plate
- Frequencies up to 18 GHz
- Load requires no AC power
- Rugged construction
- Broadband operation

SYSTEM

Coolant Method	Dry, convection-cooled
Impedance	50 Ohms
AC Power	None except 1500 W models require 115/230V AC power
Operating Position	Any

ENVIRONMENTAL

Ambient Temperature	-40 °C to 40 °C (-40 °F to 104 °F)
Humidity	95% non-condensing

LOAD CONFIGURATION GUIDE

POWER RATING	PRODUCT TYPE	CONNECTOR GENDER	CONNECTORS*
See selection guide	T, WT = Convection-cooled CT = Conduction-cooled ST = Square convection-cooled	F = Female M = Male	A = SMA B = BNC N = N T = TNC E = IEC 7/16

*Call for custom connector options not shown in this catalog

Example: 2-18T-FA = Model 2-18T, 2 W, convection-cooled load with female SMA connectors.

Note: Not all combinations are valid. If assistance is needed consult the factory to define the model that is right for you.

LOAD SELECTION GUIDE

MODEL	POWER RATING	CONNECTORS	FREQUENCY RANGE & VSWR	DIMENSIONS	WEIGHT	FINISH
2-T	2 W	BNC, 7/16 DIN, N, TNC	DC to 1 GHz @ 1.10:1 max 1 to 4 GHz @ 1.25:1 max	2.9 in x 1.4 in dia (74 mm x 36 dia mm)	4.6 oz (131 g)	Tri-Alloy
2-NT	2 W	N	DC to 1 GHz @ 1.10:1 max 1 to 3 GHz @ 1.15:1 max	2.9 in x 1.4 in dia (74 mm x 36 dia mm)	4.6 oz (131 g)	Tri-Alloy
2-18T	2 W	N	DC to 12.4 GHz @ 1.20:1 max 12.4 to 18 GHz @ 1.25:1 max	1.0 in x 0.9 in dia (26 mm x 23 dia mm)	2.0 oz (57 g)	Stainless Steel
5-T	5 W	BNC, 7/16 DIN, N, TNC	DC to 1 GHz @ 1.10:1 max 1 to 4 GHz @ 1.25:1 max	2.9 in x 1.4 in dia (74 mm x 36 dia mm)	4.6 oz (131 g)	Tri-Alloy
5-NT	5 W	N	DC to 1 GHz @ 1.10:1 max 1 to 3 GHz @ 1.15:1 max	2.9 in x 1.4 in dia (74 mm x 36 dia mm)	4.6 oz (131 g)	Tri-Alloy
5-18T	5 W	N	DC to 4 GHz @ 1.15:1 max 4 to 12.4 GHz @ 1.25:1 max 12.4 to 18 GHz @ 1.35:1 max	1.4 in x 0.9 in dia (36 mm x 23 dia mm)	2.0 oz (57 g)	Stainless Steel

**Except models 2-T, 2-NT, and 2-18T

RF Power Loads **CONVECTION-COOLED**

LOAD SELECTION GUIDE

MODEL	POWER RATING	CONNECTORS	FREQUENCY RANGE & VSWR	DIMENSIONS	WEIGHT	FINISH
10-T	10 W	N	DC to 1 GHz @ 1.10:1 max 1 to 4 GHz @ 1.25:1 max	2.2 in x 2.3 in dia (56 mm x 59 dia mm)	5.9 oz (168 g)	Black Anodized Aluminum
25-T	25 W	SMA, BNC, 7/16 DIN, N, TNC, 4.1/9.5	DC to 1 GHz @ 1.10:1 max 1 to 4 GHz @ 1.25:1 max	5.3 in x 2.3 in dia (135 mm x 59 dia mm)	7 oz (199 g)	Black Anodized Aluminum
25-6T	25 W	N	DC to 6 GHz @ 1.20:1 max	3.5 in x 2.3 in x 2.3 in (89 mm x 59 mm x 59 mm)	14.0 oz (397 g)	Black Anodized Aluminum
25-18T	25 W	N	DC to 6 GHz @ 1.20:1 max 6 to 12.4 GHz @ 1.30:1 max 12.4 to 18 GHz @ 1.40:1 max	3.5 in x 2.3 in x 2.3 in (89 mm x 59 mm x 59 mm)	14.0 oz (397 g)	Black Anodized Aluminum
50-T	50 W	SMA, BNC, 7/16 DIN, N, TNC, 4.1/9.5	DC to 1 GHz @ 1.10:1 max 1 to 4 GHz @ 1.25:1 max	5.3 in x 2.3 in dia (135 mm x 59 dia mm)	1.3 lb (590 g)	Black Anodized Aluminum
50-NT	50 W	N	DC to 1 GHz @ 1.10:1 max 1 to 3 GHz @ 1.15:1 max	5.3 in x 2.3 in dia (135 mm x 59 dia mm)	1.2 lb (545 g)	Black Anodized Aluminum
50-6T	50 W	N	1 to 6 GHz @ 1.25:1 max	4.0 in x 3.0 in x 3.0 in (102 mm x 77 mm x 77 mm)	1.6 lb (726 g)	Black Anodized Aluminum
50-18T	50 W	N	DC to 6 GHz @ 1.25:1 max 6 to 12.4 GHz @ 1.35:1 max 12.4 to 18 GHz @ 1.45:1 max	4.0 in x 3.0 in x 3.0 in (102 mm x 77 mm x 77 mm)	1.6 lb (726 g)	Black Anodized Aluminum
75-T	75 W	BNC, 7/16 DIN, N	DC to 1 GHz @ 1.10:1 max 1 to 4 GHz @ 1.25:1 max	7.2 in x 2.3 in dia (183 mm x 59 dia mm)	1.5 lb (682 g)	Black Anodized Aluminum
100-T	100 W	BNC, 7/16 DIN, N, TNC	DC to 1 GHz @ 1.10:1 max 1 to 3 GHz @ 1.25:1 max	6.8 in x 6.4 in x 2.6 in (173 mm x 163 mm x 67 mm)	3.6 lb (1.6 kg)	Stainless Steel
100-ST	100 W	BNC, 7/16 DIN, N, TNC	DC to 1 GHz @ 1.10:1 max 1 to 4 GHz @ 1.25:1 max	7.4 in x 2.8 in x 2.8 in (188 mm x 72 mm x 72 mm)	2.7 lb (1.2 kg)	Black Anodized Aluminum
100-NST	100 W	N	DC to 1 GHz @ 1.10:1 max 1 to 3 GHz @ 1.15:1 max	7.3 in x 2.8 in x 2.8 in (186 mm x 72 mm x 72 mm)	2.7 lb (1.2 kg)	Black Anodized Aluminum
100-6T	100 W	N	DC to 2 GHz @ 1.20:1 max 2 to 4 GHz @ 1.30:1 max 4 to 6 GHz @ 1.40:1 max	5.5 in x 3.5 in x 3.8 in (140 mm x 89 mm x 97 mm)	2.2 lb (1.0 kg)	Black Anodized Aluminum
150-T	150 W	BNC, N	DC to 1 GHz @ 1.10:1 max 1 to 3.0 GHz @ 1.25:1 max	6.8 in x 11.5 in x 2.6 in (173 mm x 293 mm x 67 mm)	6.0 lb (2.8 kg)	Black Anodized Aluminum
150-ST	150 W	N	DC to 1 GHz @ 1.10:1 max 1 to 3.0 GHz @ 1.25:1 max	8.1 in x 4.0 in x 4.0 in (206 mm x 102 mm x 102 mm)	5.0 lb (2.3 kg)	Black Anodized Aluminum
150-WT	150 W	N	DC to 1 GHz @ 1.10:1 max 1 to 3.0 GHz @ 1.25:1 max	4.9 in x 5.4 in x 4.8 in (125 mm x 138 mm x 122 mm)	2.5 lb (1.2 kg)	Black Anodized Aluminum
300-T	300 W	N	DC to 1 GHz @ 1.10:1 max 1 to 2.4 GHz @ 1.25:1 max	7.4 in x 5.4 in x 10.9 in (188 mm x 138 x 277 mm)	11.5 lb (5.3 kg)	Black Anodized Aluminum
300-WT	300 W	7/16 DIN, N	DC to 1 GHz @ 1.10:1 max 1 to 2.4 GHz @ 1.25:1 max	8.2 in x 5.4 in x 4.8 in (209 mm x 138 x 122 mm)	4.7 lb (2.2 kg)	Black Anodized Aluminum
500-WT	500 W	7/16 DIN, N	DC to 1 GHz @ 1.10:1 max 1 to 2.4 GHz @ 1.25:1 max	11.0 in x 5.4 in x 4.8 in (280 mm x 138 mm x 122 mm)	7.8 lb (3.6 kg)	Black Anodized Aluminum
600-T	600 W	7/16 DIN, N	DC to 1 GHz @ 1.10:1 max 1 to 2.4 GHz @ 1.25:1 max	12.4 in x 9.6 in x 7.4 in (315 mm x 244 mm x 188 mm)	21.5 lb (9.8 kg)	Black Anodized Aluminum
1000-T	1 kW	N	DC to 1 GHz @ 1.10:1 max 1 to 2.4 GHz @ 1.25:1 max	12.3 in x 9.6 in x 12.8 in (313 mm x 244 mm x 326 mm)	26.5 lb (12.0 kg)	Black Anodized Aluminum
1000-WT	1 kW	7/16 DIN, N	DC to 1 GHz @ 1.10:1 max 1 to 2.4 GHz @ 1.25:1 max	18.5 in x 10.6 in x 4.8 in (470 mm x 270 mm x 122 mm)	26.5 lb (12.0 kg)	Black Anodized Aluminum
1500-WT**	1.5 kW	7/16 DIN, N	DC to 1 GHz @ 1.10:1 max 1 to 2.4 GHz @ 1.25:1 max	20 in x 10.6 in x 6.0 in (508 mm x 270 mm x 152 mm)	30.0 lb (13.6 kg)	Black Anodized Aluminum
1500-WA**	1.5 kW	N	DC to 1 GHz @ 1.10:1 max 1 to 2.4 GHz @ 1.25:1 max	20.4 in x 10.7 in x 5.9 in (519 mm x 272 mm x 150 mm)	30.0 lb (13.6 kg)	Black Anodized Aluminum

**1.5 kW Models require 115/230V AC Power



RF Loads

OIL-COOLED

Bird's Oil-Cooled RF Loads are self-contained high-power 50 Ohm coaxial transmission line terminations requiring no outside power source or additional equipment. These units provide accurate, dependable, and practically non-reflective termination for testing and adjusting transmitters under non-radiating conditions. The loads consist essentially of a cylindrical film type resistor immersed in a dielectric coolant. The resistor, individually selected for its accuracy, is enclosed in a special tapered housing which provides a linear reduction in surge impedance directly proportional to the distance along the resistor.

PRODUCT FEATURES

- Self-contained cooling system that includes cooling fans for higher power models
- Capable of up to 10 dB peak to average power ratios
- Wide range of available RF input connectors
- Compact design
- Broadband operation

SYSTEM

Coolant Method	8135, 8201, 8251: Refined mineral oil All Others: Silicone oil
Impedance	50 Ohms
Finish	Gray powder coat
AC Power	None except 1500 W models require 115/230V AC power
Operating Position	Vertical

ENVIRONMENTAL

Ambient Temperature	-40 °C to 45 °C (-40 °F to 113 °F)
Storage Temperature	-40 °C to 45 °C (-40 °F to 113 °F)
Humidity	95% non-condensing
Altitude	1520 m (5000 ft)

CERTIFICATIONS

Safety	EMC EN 61326-1:2006 (units w/blowers) and Safety EN 61010-1:2001 (all units)
---------------	---

LOAD SELECTION GUIDE

MODEL	POWER RATING	CONNECTORS	COOLING METHOD	FREQ. RANGE & VSWR	DIMENSIONS	WEIGHT
8135	150 W	QC - N(F)	Convection	DC to 1 GHz @ 1.1:1 max 1 to 2.5 GHz @ 1.2:1 max 2.5 to 4 GHz @ 1.3:1 max	9.6 in x 6.5 in x 4 in (242 mm x 164 mm x 102 mm)	6.0 lb (2.7 kg)
8141	250 W	QC - N(F)	Convection	DC to 1 GHz @ 1.1:1 max 1 to 1.8 GHz @ 1.2:1 max 1.8 to 2.5 GHz @ 1.3:1 max	9.6 in x 8.5 in x 6 in (243 mm x 216 mm x 151 mm)	10 lb (4.5 kg)
8201	500 W	QC - N(F)	Convection	DC to 1 GHz @ 1.1:1 max 1 to 2.5 GHz @ 1.25:1 max	16.8 in x 8.5 in x 6 in (427 mm x 216 mm x 151 mm)	20 lb (9.1 kg)
8401	600 W	QC - N(F)	Convection	DC to 1 GHz @ 1.1:1 max 1 to 2.8 GHz @ 1.2:1 max 2.8 to 3 GHz @ 1.3:1 max	16.2 in x 8.5 in x 6 in (408 mm x 216 mm x 151 mm)	20 lb (9.1 kg)
8251	1 kW	QC - N(F)	Convection	DC to 1 GHz @ 1.1:1 max 1 to 2 GHz @ 1.25:1 max 2 to 2.4 GHz @ 1.3:1 max	17.9 in x 8.5 in x 6 in (455 mm x 216 mm x 151 mm)	25 lb (11.5 kg)
8860	1.5 kW	QC - N(F)	Convection	DC to 1 GHz @ 1.1:1 max 1 to 2 GHz @ 1.25:1 max	19.5 in x 7.5 in x 13.2 in (496 mm x 184 mm x 334 mm)	32 lb (14.5 kg)
8861	1.5 kW	1 5/8 in EIA Unflanged	Convection	DC to 1 GHz @ 1.1:1 max 1 to 2 GHz @ 1.25:1 max	19.5 in x 7.5 in x 13.2 in (496 mm x 184 mm x 334 mm)	32 lb (14.5 kg)
8862	1.5 kW	1 5/8 in EIA Flanged	Convection	DC to 1 GHz @ 1.1:1 max 1 to 2 GHz @ 1.25:1 max	19.5 in x 7.5 in x 13.2 in (496 mm x 184 mm x 334 mm)	32 lb (14.5 kg)

RF Loads **OIL-COOLED**

LOAD SELECTION GUIDE

MODEL	POWER RATING	CONNECTORS	COOLING METHOD	FREQ. RANGE & VSWR	DIMENSIONS	WEIGHT
8890-300	2.5 kW	QC - LC(F)	Convection	DC to 1 GHz @ 1.1 max 1 to 2 GHz @ 1.25:1 max 2 to 2.4 GHz @ 1.3 max	25.2 in x 7 in x 17.2 in (638 mm x 178 mm x 437 mm)	59 lb (27 kg)
8891-300	2.5 kW	3 1/8 in EIA Flanged	Convection	DC to 1 GHz @ 1.1:1 max 1 to 2 GHz @ 1.25:1 max 2 to 2.4 GHz @ 1.3 max	25.2 in x 7 in x 17.2 in (638 mm x 178 mm x 437 mm)	59 lb (27 kg)
8892-300	2.5 kW	1 5/8 in EIA Flanged	Convection	DC to 1 GHz @ 1.1:1 max 1 to 2 GHz @ 1.25:1 max 2 to 2.4 GHz @ 1.3 max	25.2 in x 7 in x 17.2 in (638 mm x 178 mm x 437 mm)	59 lb (27 kg)
8895-300	2.5 kW	1 5/8 in EIA Unflanged	Convection	DC to 1 GHz @ 1.1:1 max 1 to 2 GHz @ 1.25:1 max 2 to 2.4 GHz @ 1.3 max	25.2 in x 7 in x 17.2 in (638 mm x 178 mm x 437 mm)	59 lb (27 kg)
8890-315	5 kW	QC - LC(F)	115 VAC Fan	DC to 1 GHz @ 1.1:1 max 1 to 2 GHz @ 1.25:1 max 2 to 2.4 GHz @ 1.3 max	25.2 in x 7.4 in x 22.7 in (638 mm x 187 mm x 560 mm)	73 lb (33 kg)
8890-320	5 kW	QC - LC(F)	230 VAC Fan	DC to 1 GHz @ 1.1:1 max 1 to 2 GHz @ 1.25:1 max 2 to 2.4 GHz @ 1.3 max	25.2 in x 7.4 in x 22.7 in (638 mm x 187 mm x 560 mm)	73 lb (33 kg)
8891-315	5 kW	3 1/8 in EIA Flanged	115 VAC Fan	DC to 1 GHz @ 1.1:1 max 1 to 2 GHz @ 1.25:1 max 2 to 2.4 GHz @ 1.3 max	25.2 in x 7.4 in x 22.7 in (638 mm x 187 mm x 560 mm)	73 lb (33 kg)
8891-320	5 kW	3 1/8 in EIA Flanged	230 VAC Fan	DC to 1 GHz @ 1.1:1 max 1 to 2 GHz @ 1.25:1 max 2 to 2.4 GHz @ 1.3 max	25.2 in x 7.4 in x 22.7 in (638 mm x 187 mm x 560 mm)	73 lb (33 kg)
8892-315	5 kW	1 5/8 in EIA Flanged	115 VAC Fan	DC to 1 GHz @ 1.1:1 max 1 to 2 GHz @ 1.25:1 max 2 to 2.4 GHz @ 1.3 max	25.2 in x 7.4 in x 22.7 in (638 mm x 187 mm x 560 mm)	73 lb (33 kg)
8892-320	5 kW	1 5/8 in EIA Flanged	230 VAC Fan	DC to 1 GHz @ 1.1:1 max 1 to 2 GHz @ 1.25:1 max 2 to 2.4 GHz @ 1.3 max	25.2 in x 7.4 in x 22.7 in (638 mm x 187 mm x 560 mm)	73 lb (33 kg)
8895-315	5 kW	1 5/8 in EIA Unflanged	115 VAC Fan	DC to 1 GHz @ 1.1:1 max 1 to 2 GHz @ 1.25:1 max 2 to 2.4 GHz @ 1.3 max	25.2 in x 7.4 in x 22.7 in (638 mm x 187 mm x 560 mm)	73 lb (33 kg)
8895-320	5 kW	1 5/8 in EIA Unflanged	230 VAC Fan	DC to 1 GHz @ 1.1:1 max 1 to 2 GHz @ 1.25:1 max 2 to 2.4 GHz @ 1.3 max	25.2 in x 7.4 in x 22.7 in (638 mm x 187 mm x 560 mm)	73 lb (33 kg)
8921	5 kW	QC - LC(F)	Convection	DC to 1 GHz @ 1.1:1 max	32.8 in x 9.5 in x 26.9 in (832 mm x 241 mm x 681 mm)	126 lb (57 kg)
8922	5 kW	1 5/8 in EIA Flanged	Convection	DC to 1 GHz @ 1.1:1 max	32.8 in x 9.5 in x 26.9 in (832 mm x 241 mm x 681 mm)	126 lb (57 kg)
8926	5 kW	3 1/8 in EIA Flanged	Convection	DC to 1 GHz @ 1.1:1 max	32.8 in x 9.5 in x 26.9 in (832 mm x 241 mm x 681 mm)	126 lb (57 kg)
8931-115	10 kW	QC - LC(F)	115 VAC Fan	DC to 400 MHz @ 1.15:1 max 400 MHz to 1 GHz @ 1.2:1 max	32.8 in x 9.5 in x 33.4 in (832 mm x 241 mm x 847 mm)	142 lb (65 kg)
8931-230	10 kW	QC - LC(F)	230 VAC Fan	DC to 400 MHz @ 1.15:1 max 400 MHz to 1 GHz @ 1.2:1 max	32.8 in x 9.5 in x 33.4 in (832 mm x 241 mm x 847 mm)	142 lb (65 kg)
8932-115	10 kW	1 5/8 in EIA Flanged	115 VAC Fan	DC to 400 MHz @ 1.15:1 max 400 MHz to 1 GHz @ 1.2:1 max	32.8 in x 9.5 in x 33.4 in (832 mm x 241 mm x 847 mm)	142 lb (65 kg)
8932-230	10 kW	1 5/8 in EIA Flanged	230 VAC Fan	DC to 400 MHz @ 1.15:1 max 400 MHz to 1 GHz @ 1.2:1 max	32.8 in x 9.5 in x 33.4 in (832 mm x 241 mm x 847 mm)	142 lb (65 kg)
8936-115	10 kW	3 1/8 in EIA Flanged	115 VAC Fan	DC to 400 MHz @ 1.15:1 max 400 MHz to 1 GHz @ 1.2:1 max	32.8 in x 9.5 in x 33.4 in (832 mm x 241 mm x 847 mm)	142 lb (65 kg)
8936-230	10 kW	3 1/8 in EIA Flanged	230 VAC Fan	DC to 400 MHz @ 1.15:1 max 400 MHz to 1 GHz @ 1.2:1 max	32.8 in x 9.5 in x 33.4 in (832 mm x 241 mm x 847 mm)	142 lb (65 kg)



Market Specific RF Loads

OIL-COOLED

Bird's Oil-Cooled RF Loads for Digital Broadcast and Semiconductor Precision applications are self-contained high-power 50 Ohm coaxial transmission line terminations requiring no outside power source or additional equipment. These coaxial load resistors provide accurate, dependable, and practically non-reflective termination for testing and adjusting transmitters under non-radiating conditions.

PRODUCT FEATURES

- Self-contained cooling system that includes cooling fans for higher power models
- Tuned for optimal performance over target frequency ranges
- Capable of up to 10 dB peak to average power ratios
- Wide range of available RF input connectors
- Compact design

SYSTEM

Coolant Method	Silicone oil
Impedance	50 Ohms
Finish	Digital Broadcast: Gray powder coat Semiconductor: Black powder coat
AC Power	None except 1.5 kW models require 115/230V AC power
Operating Position	Vertical

ENVIRONMENTAL

Ambient Temperature	Digital Broadcast: -40 °C to 45 °C (-40 °F to 113 °F) Semiconductor: 5 °C to 40 °C (41 °F to 104 °F)
Storage Temperature	-40 °C to 45 °C (-40 °F to 113 °F)
Humidity	95% non-condensing
Altitude	1520 m (5000 ft)

DIGITAL BROADCAST LOAD SELECTION GUIDE

MODEL	POWER RATING	CONNECTORS	COOLING METHOD	FREQ. RANGE & VSWR	DIMENSIONS	WEIGHT
8251D	1 kW	1 5/8 in EIA Flanged	Convection	470 to 860 MHz @ 1.065:1 max	17.9 in x 8.5 in x 6 in	25 lb
8251D7-16	1 kW	QC-DIN(F)	Convection	470 to 860 MHz @ 1.065:1 max	(455 mm x 216 mm x 151 mm)	(11.5 kg)
8862D	1.5 kW	1 5/8 in EIA Flanged	Convection	470 to 860 MHz @ 1.065:1 max	19.5 in x 7.5 in x 13.2 in	32 lb
					(496 mm x 184 mm x 334 mm)	(14.5 kg)
8891D300	2.5 kW	3 1/8 in EIA Flanged	Convection	470 to 860 MHz @ 1.065:1 max	25.2 in x 7 in x 17.2 in	59 lb
8892D300	2.5 kW	1 5/8 in EIA Flanged	Convection	470 to 860 MHz @ 1.065:1 max	(638 mm x 178 mm x 437 mm)	(27 kg)
8892D320	5 kW	1 5/8 in EIA Flanged	230 VAC Fan	470 to 860 MHz @ 1.065:1 max	25.2 in x 7 in x 17.2 in	73 lb
					(638 mm x 178 mm x 437 mm)	(33 kg)
8922D	5 kW	1 5/8 in EIA Flanged	Convection	470 to 860 MHz @ 1.065:1 max	32.8 in x 9.5 in x 26.9 in	126 lb
8926D	5 kW	3 1/8 in EIA Flanged	Convection	470 to 860 MHz @ 1.065:1 max	(832 mm x 241 mm x 681 mm)	(57 kg)
8927D	5 kW	3 1/8 in EIA Flanged	Convection	470 to 860 MHz @ 1.065:1 max		
8936D115	10 kW	3 1/8 in EIA Flanged	115 VAC Fan	470 to 860 MHz @ 1.15:1 max	32.8 in x 9.5 in x 33.4 in	142 lb
8936D230	10 kW	3 1/8 in EIA Flanged	230 VAC Fan	470 to 860 MHz @ 1.15:1 max	(832 mm x 241 mm x 847 mm)	(65 kg)

SEMICONDUCTOR PRECISION LOAD SELECTION GUIDE

MODEL	POWER RATING	CONNECTORS	COOLING METHOD	FREQ. RANGE & VSWR	DIMENSIONS	WEIGHT
8865SC13	1 kW	QC-LC(F)	Convection	DC to 28 MHz @ 1.10:1 max	19.5 in x 7.5 in x 13.2 in	32 lb
					(496 mm x 184 mm x 334 mm)	(14.5 kg)
8890-300SC13	2.5 kW	QC-LC(F)	Convection	DC to 28 MHz @ 1.10:1 max	25.2 in x 7 in x 17.2 in	59 lb
					(638 mm x 178 mm x 437 mm)	(27 kg)
8921SC13	5 kW	QC-LC(F)	Convection	DC to 28 MHz @ 1.10:1 max	32.8 in x 9.5 in x 26.9 in	126 lb
					(832 mm x 241 mm x 681 mm)	(57 kg)
8931-115SC13	10 kW	QC-LC(F)	115 VAC Fan	DC to 28 MHz @ 1.10:1 max	32.8 in x 9.5 in x 33.4 in	142 lb
8931-230SC13	10 kW	QC-LC(F)	230 VAC Fan	DC to 28 MHz @ 1.10:1 max	(832 mm x 241 mm x 847 mm)	(65 kg)
8941-115SC13	15 kW	QC-DIN(F)	115 VAC Fan	DC to 28 MHz @ 1.10:1	43 in x 9.5 in x 33.4 in	236 lb
8941-230SC13	15 kW	QC-DIN(F)	230 VAC Fan	DC to 28 MHz @ 1.10:1	(1092 mm x 241 mm x 847 mm)	(107 kg)



Econoloads

WATER-COOLED

Econoloads are designed as a compact, low VSWR and non-radiating termination for high-power transmitter/transmission line systems. It generates almost no ambient heat, making installation space minimal and convenient, in any position. The RF power is converted to heat in the hollow resistive film load resistor and directly absorbed by the water flowing through it.

LOAD SELECTION GUIDE

MODEL	POWER RATING	CONNECTORS	FREQUENCY RANGE & VSWR	FLOW RATE	DIMENSIONS	WEIGHT
8720	5 kW	1 5/8 in EIA Flanged	DC to 500 MHz @ 1.1:1 max 500 to 900 MHz @ 1.15:1 max 900 to 2000 MHz @ 1.25:1 max	1 GPM (4 LPM) @ 5 °C to 4 GPM (15 LPM) @ 80 °C	8.1 in x 3.5 in dia (204 mm x 89 mm dia)	2 lb 2 oz (964 g)
8726	5 kW	QC - LC(F)	DC to 500 MHz @ 1.1:1 max 500 to 2000 MHz @ 1.25:1 max	1 GPM (4 LPM) @ 5 °C to 4 GPM (15 LPM) @ 80 °C	10.5 in x 1.7 in dia (265 mm x 43 mm dia)	2 lb 8 oz (1.1 kg)
8730A	10 kW	1 5/8 in EIA Flanged	DC to 1 GHz @ 1.1:1 max	4 GPM (15 LPM) @ 5 °C to 6 GPM (23 LPM) @ 60 °C	16.0 in x 4.4 in dia (406 mm x 111 mm dia)	8 lb (3.6 kg)
8731	10 kW	3 1/8 in EIA Flanged	1 kHz to 1 GHz @ 1.1:1 max	4 GPM (15 LPM) @ 5 °C to 6 GPM (23 LPM) @ 60 °C	14.7 in x 5.2 in dia (372 mm x 132 mm dia)	6 lb 4 oz (2.9 kg)
8738A	10 kW	3 1/8 in EIA Unflanged	1 kHz to 1 GHz @ 1.1:1 max	4 GPM (15 LPM) @ 5 °C to 6 GPM (23 LPM) @ 60 °C	16.0 in x 4.4 in dia (406 mm x 111 mm dia)	6 lb (2.8 kg)
8745	20 kW	3 1/8 in EIA Flanged	1 kHz to 900 MHz @ 1.1:1 max	6 GPM (23 LPM) @ 5 °C to 8 GPM (30 LPM) @ 60 °C	19.5 in x 5.2 in dia (495 mm x 132 mm dia)	15 lb 13 oz (7.2 kg)
8746	20 kW	3 1/8 in EIA Unflanged	1 kHz to 900 MHz @ 1.1:1 max	6 GPM (23 LPM) @ 5 °C to 8 GPM (30 LPM) @ 60 °C	19.5 in x 5.2 in dia (495 mm x 132 mm dia)	15 lb 5 oz (7.0 kg)
8755	30 kW	3 1/8 in EIA Flanged	1 kHz to 900 MHz @ 1.1:1 max	7 GPM (26 LPM) @ 5 °C to 9 GPM (34 LPM) @ 60 °C	19.5 in x 5.2 in dia (495 mm x 132 mm dia)	15 lb 13 oz (7.2 kg)
8756	30 kW	3 1/8 in EIA Unflanged	1 kHz to 900 MHz @ 1.1:1 max	7 GPM (26 LPM) @ 5 °C to 9 GPM (34 LPM) @ 60 °C	19.5 in x 5.2 in dia (495 mm x 132 mm dia)	15 lb 5 oz (7.0 kg)
8765	40 kW	3 1/8 in EIA Flanged	1 kHz to 900 MHz @ 1.1:1 max	8 GPM (30 LPM) @ 5 °C to 10 GPM (38 LPM) @ 60 °C	19.5 in x 5.2 in dia (495 mm x 132 mm dia)	15 lb 13 oz (7.2 kg)
8775	50 kW	3 1/8 in EIA Flanged	1 kHz to 900 MHz @ 1.1:1 max	9 GPM (34 LPM) @ 5 °C to 11 GPM (42 LPM) @ 60 °C	19.5 in x 5.2 in dia (495 mm x 132 mm dia)	15 lb 13 oz (7.2 kg)
8776	50 kW	3 1/8 in EIA Unflanged	1 kHz to 900 MHz @ 1.1:1 max	9 GPM (34 LPM) @ 5 °C to 11 GPM (42 LPM) @ 60 °C	19.5 in x 5.2 in dia (495 mm x 132 mm dia)	15 lb 5 oz (7.0 kg)
8792	80 kW	6 1/8 in EIA Flanged	1 kHz to 800 MHz @ 1.15:1 max	9 GPM (34 LPM) @ 5 °C to 12 GPM (46 LPM) @ 60 °C	35.2 in x 8.2 in dia (891 mm x 206 mm dia)	25 lb (11.3 kg)

PRODUCT FEATURES

- Econoloads are the smallest load design for power dissipation
- Utilizes an external water supply where there is a source of potable water
- Compact size may be carried easily, mounted in any orientation
- Load requires no AC power
- Surface cool to the touch
- Standard EIA RF connections and NPT water connection

SYSTEM

Coolant Method	Water-cooled
Impedance	50 Ohms
AC Power	None
Operating Position	Any
Waterlines	5 kW, 8720: 1/4 in FPT 5 kW, 8726: 3/4 in hose 10 kW to 80 kW: 3/4 in hose

ENVIRONMENTAL

Water Inlet Temperature	5 kW: -8 °C to 40 °C (17.6 °F to 104 °F) 10 kW to 80 kW: -5 °C to 60 °C (23 °F to 140 °F)
--------------------------------	--



MADE IN USA

Digital Air Loads

DA SERIES AIR-COOLED

DA-Series, Digital Air RF Loads are forced air-cooled loads that provide a fully self-contained and convenient means of dissipating large amounts of analog or digital RF power. Digital Air loads require no plumbing, pumps or complicated installation and setup procedures. The four fan design provides excellent cooling efficiency as well as extremely high reliability.

LOAD SELECTION GUIDE

VHF LOAD	CONNECTOR	AC POWER	POWER RATING	FREQUENCY RANGE	DIMENSIONS	WEIGHT
DA10V1F15	1 5/8 in Flanged	115 VAC	10 kW	0 to 240 MHz to AM, FM, VHF	23.5 in x 23.5 in x 59 in (597 mm x 597 mm x 1499 mm)	130 lb (58.97 kg)
DA10V1U15	1 5/8 in Unflanged					
DA10V1F30	1 5/8 in Flanged	230 VAC	10 kW	0 to 240 MHz to AM, FM, VHF	23.5 in x 23.5 in x 59 in (597 mm x 597 mm x 1499 mm)	130 lb (58.97 kg)
DA10V1U30	1 5/8 in Unflanged					
DA10V3F15	3 1/8 in Flanged	115 VAC	10 kW	0 to 240 MHz to AM, FM, VHF	23.5 in x 23.5 in x 59 in (597 mm x 597 mm x 1499 mm)	130 lb (58.97 kg)
DA10V3U15	3 1/8 in Unflanged					
DA10V3F30	3 1/8 in Flanged	230 VAC	10 kW	0 to 240 MHz to AM, FM, VHF	23.5 in x 23.5 in x 59 in (597 mm x 597 mm x 1499 mm)	130 lb (58.97 kg)
DA10V3U30	3 1/8 in Unflanged					
DA25V3F15	3 1/8 in Flanged	115 VAC	25 kW	0 to 240 MHz to AM, FM, VHF	27 in x 27 in x 61 in (686 mm x 686 mm x 1549 mm)	160 lb (72.57 kg)
DA25V3U15	3 1/8 in Unflanged					
DA25V3F30	3 1/8 in Flanged	230 VAC	25 kW	0 to 240 MHz to AM, FM, VHF	27 in x 27 in x 61 in (686 mm x 686 mm x 1549 mm)	160 lb (72.57 kg)
DA25V3U30	3 1/8 in Unflanged					
DA25V4U15	4 1/2 in Unflanged	115 VAC	25 kW	0 to 240 MHz to AM, FM, VHF	27 in x 27 in x 61 in (686 mm x 686 mm x 1549 mm)	160 lb (72.57 kg)
DA25V4U30	4 1/2 in Unflanged	230 VAC				

PRODUCT FEATURES

- Self-contained and convenient means of dissipating large amounts analog, digital, and combined signals
- Excellent VSWR performance with <1.05:1 typical VSWR (1.1:1 max) across rated frequency range
- Handles >13 dB Peak to Average power ratio
- Ductable exhaust and cool-to-the-touch exterior surfaces
- Double shielded against the production of extraneous radiation

MEASUREMENT

Impedance	50 Ohms nominal
VSWR	1.05:1 typical, 1.10:1 max
VHF (DC-240 MHz)	1.05:1 typical, 1.10:1 max
UHF (470 to 890 MHz)	
Peak to Average Power	>10 dB

SYSTEM

Cooling Method	Forced air-cooled
Interlock Contact Rating	10 A @ 120 VAC, 5 A @ 250 VAC
Finish	Blue Powder Coat
Power Requirements	115 V/230 V 50/60 Hz

ENVIRONMENTAL

Operating Temperature	-40 °C to 45 °C (-40 °F to 113 °F)
-----------------------	------------------------------------

CERTIFICATIONS

CE	EMC: EN 61326-1:2006 and Safety: EN 61010-1:2001
----	---

Digital Air Loads **DA SERIES AIR-COOLED**

LOAD SELECTION GUIDE

UHF LOAD	CONNECTOR	AC POWER	POWER RATING	FREQUENCY RANGE	DIMENSIONS	WEIGHT
DA5F15	3 1/8 in Flanged	115 VAC	5 kW	470 to 890 MHz UHF	17 in x 17 in x 64 in (495 mm x 495 mm x 1740 mm)	100 lb (45.5 kg)
DA5U15	3 1/8 in Unflanged					
DA5F30	3 1/8 in Flanged	230 VAC	5 kW	470 to 890 MHz UHF	17 in x 17 in x 64 in (495 mm x 495 mm x 1740 mm)	100 lb (45.5 kg)
DA5U30	3 1/8 in Unflanged					
DA10F15	3 1/8 in Flanged	115 VAC	10 kW	470 to 890 MHz UHF	19.5 in x 19.5 in x 68.5 in (432 mm x 432 mm x 1608 mm)	130 lb (58.97 kg)
DA10U15	3 1/8 in Unflanged					
DA10F30	3 1/8 in Flanged	230 VAC	10 kW	470 to 890 MHz UHF	19.5 in x 19.5 in x 68.5 in (432 mm x 432 mm x 1608 mm)	130 lb (58.97 kg)
DA10U30	3 1/8 in Unflanged					
DA15F15	3 1/8 in Flanged	115 VAC	15 kW	470 to 890 MHz UHF	25 in x 25 in x 76.5 in (635 mm x 635 mm x 1943 mm)	192 lb (87.09 kg)
DA15U15	3 1/8 in Unflanged					
DA15F30	3 1/8 in Flanged	230 VAC	15 kW	470 to 890 MHz UHF	25 in x 25 in x 76.5 in (635 mm x 635 mm x 1943 mm)	192 lb (87.09 kg)
DA15U30	3 1/8 in Unflanged					
DA25F15	4 1/16 in Myat Flanged	115 VAC	25 kW	470 to 890 MHz UHF	27 in x 27 in x 76.5 in (686 mm x 686 mm x 1943 mm)	245 lb (111.13 kg)
DA25U15	4 1/16 in Myat Unflanged					
DA25F30	4 1/16 in Myat Flanged	230 VAC	25 kW	470 to 890 MHz UHF	27 in x 27 in x 76.5 in (686 mm x 686 mm x 1943 mm)	245 lb (111.13 kg)
DA25U30	4 1/16 in Myat Unflanged					
DA25 to 4U15	4 1/2 in IEC Unflanged	115 VAC	25 kW	470 to 890 MHz UHF	27 in x 27 in x 76.5 in (686 mm x 686 mm x 1943 mm)	245 lb (111.13 kg)
DA25 to 4U30	4 1/2 in IEC Unflanged	230 VAC				
DA40 to 5U15	4 7/8 in IEC Unflanged	115 VAC	40 kW	470 to 890 MHz UHF	27.5 in x 27.5 in x 84 in (701 mm x 701 mm x 2134 mm)	310 lb (140.6 kg)
DA40 to 5U30	4 7/8 in IEC Unflanged	230 VAC				
DA40F15	6 1/8 in IEC Flanged	115 VAC	40 kW	470 to 890 MHz UHF	27.5 in x 27.5 in x 84 in (701 mm x 701 mm x 2134 mm)	310 lb (140.6 kg)
DA40F30	6 1/8 in IEC Flanged	230 VAC				
DA40U30	6 1/8 in IEC Unflanged	230 VAC				

Note: Other models available, please consult factory.



PRODUCT FEATURES

- Forced-air heat exchanger cooled load for high-power applications up to 900 MHz
- High power RF dissipation with 10, 25 and 50 kW versions are available
- Compact, low-profile design saves space in crowded transmitter sites
- Interlock control circuit provides fail-safe protection of the transmitter
- Available in models to work with 115 or 230 V at 50 or 60 Hz
- Optional Load Protection Switch available as a safeguard against costly damage and downtime

SYSTEM

Coolant Method	Forced air
Load Coolant	Dependent on power rating, 100% water or 35% Ethylene glycol/65% water
Frequency Range/VSWR	10 kW: 1 kHz to 1000 MHz at 1.1:1 max 25 kW & 50 kW: 1 kHz to 900 MHz at 1.1:1 max
Operating Position	Horizontal
Finish	Grey powder coat

ENVIRONMENTAL

Operating Temperature	Dependent on power rating and load coolant. See chart.
------------------------------	--

CERTIFICATIONS

CE	EMC: EN 61326-1:2006 and Safety: EN 61010-1:2001
-----------	---

Moduloads

FORCED AIR-COOLED

Bird's Moduloads are self-cooling, low reflection, non-radiating terminations for higher power 50 Ohm RF transmission lines efficient at dissipation of RF over a wide frequency range. The equipment consists of three basic systems: the RF load assembly, the control system, and the heat exchanger system. Useable with CW, AM, FM, SSB, and TV modulation, and certain pulse types.

LOAD SELECTION GUIDE

MODEL	INPUT POWER	POWER RATING & OPERATING TEMPERATURE	CONNECTOR	DIMENSIONS	WEIGHT
8631B115	9.5 A @ 115 V, 60 Hz	10 kW - 100% Water: 5 °C to 45 °C 35% Ethylene Glycol/65% Water: -20 °C to 35 °C	3 1/8 in EIA Flanged	24.6 in x 15.9 in x 17.5 in (623 mm x 402 mm x 443 mm)	113 lb (50.9 kg)
8631B230	4.75 A @ 230 V, 50 Hz		3 1/8 in EIA Flanged	24.6 in x 15.9 in x 17.5 in (623 mm x 402 mm x 443 mm)	113 lb (50.9 kg)
8635B115	9.5 A @ 115 V, 60 Hz		1 5/8 in EIA Flanged	24.6 in x 15.9 in x 17.5 in (623 mm x 402 mm x 443 mm)	113 lb (50.9 kg)
8635B230	4.75 A @ 230 V, 50 Hz		1 5/8 in EIA Flanged	24.6 in x 15.9 in x 17.5 in (623 mm x 402 mm x 443 mm)	113 lb (50.9 kg)
8645B115	11 A @ 115 V, 60 Hz	25 kW - 100% Water: 5 °C to 30 °C 35% Ethylene Glycol / 65% Water: -20 °C to 25 °C	3 1/8 in EIA Flanged	28.5 in x 19.6 in x 20.9 in (723 mm x 497 mm x 528 mm)	155 lb (70 kg)
8645B230	5.5 A @ 230 V, 50 Hz		3 1/8 in EIA Flanged	28.5 in x 19.6 in x 20.9 in (723 mm x 497 mm x 528 mm)	155 lb (70 kg)
8645B230-6	5.5 A @ 230 V, 60 Hz	20 kW - 100% Water: 5 °C to 45 °C 35% Ethylene Glycol / 65% Water: -20 °C to 35 °C	3 1/8 in EIA Flanged	28.5 in x 19.6 in x 20.9 in (723 mm x 497 mm x 528 mm)	155 lb (70 kg)
8655B115-6	15 A @ 115 V, 60 Hz		3 1/8 in EIA Flanged	53 in x 19.6 in x 20.9 in (1347 mm x 497 mm x 528 mm)	275 lb (125 kg)
8655B230-5	8 A @ 230 V, 50 Hz	40kW - 100% Water: 5 °C to 45 °C 35% Ethylene Glycol / 65% Water: -20 °C to 35 °C	3 1/8 in EIA Flanged	53 in x 19.6 in x 20.9 in (1347 mm x 497 mm x 528 mm)	275 lb (125 kg)
8655B230-6	8 A @ 230 V, 60 Hz		3 1/8 in EIA Flanged	53 in x 19.6 in x 20.9 in (1347 mm x 497 mm x 528 mm)	275 lb (125 kg)

LOAD PROTECTION SWITCH GUIDE

MODEL	INPUT POWER	POWER RATING	CONNECTOR	DESCRIPTION
8640A930-1	24VDC (from included universal input power adapter)	60kW at 2MHz 20kW at 60MHz 16kW at 120MHz	3-1/8 in EIA Flanged	Provides an added layer of safety for the water-cooled Moduloads by preventing RF power from reaching it before proper coolant flow has been established, protecting it from damage that can result in costly downtime.

MADE IN
USA

RF Power Attenuators

OIL CONVECTION-COOLED

The Bird oil convection-cooled attenuator 8320 Series may be used for the isolation of power sources up to their maximum power rating and for low level monitoring. They are valuable and reliable accessories for reducing power levels and VSWR, for isolating components under test, for harmonic signal analysis, and as comparison standards.

ATTENUATOR SELECTION GUIDE

MODEL	POWER RATING	CONNECTOR	FREQ. RANGE & VSWR	COOLING METHOD	DIMENSIONS	WEIGHT
8325	500 W	QC - N(F) Input QC - N(F) Output	DC to 500 MHz at 1.1:1 max	Convection	17.5 in x 6.0 in x 8.5 in (445 mm x 151 mm x 216 mm)	25 lb (11.0 kg)
8327-300	1 kW	QC - LC(F) Input QC - N(F) Output	DC to 500 MHz at 1.1:1 max	Convection	24.0 in x 7.2 in x 17.2 in (596 mm x 181 mm x 437 mm)	57 lb (26.0 kg)
8329-300	2 kW	QC - LC(F) Input QC - N(F) Output	DC to 500 MHz at 1.1:1 max	Convection	24.0 in x 7.2 in x 17.2 in (596 mm x 181 mm x 437 mm)	57 lb (26.0 kg)
8329-300 w/ BA-300-115	4 kW	QC - LC(F) Input QC - N(F) Output	DC to 500 MHz at 1.1:1 max	Forced Convection, 115 VAC Fan	23.5 in x 7.2 in x 22.1 in (596 mm x 181 mm x 560 mm)	70.5 lb (32 kg)
8329-300 w/ BA-300-230	4 kW	QC - LC(F) Input QC - N(F) Output	DC to 500 MHz at 1.1:1 max	Forced Convection, 230 VAC Fan	23.5 in x 7.2 in x 22.1 in (596 mm x 181 mm x 560 mm)	70.5 lb (32 kg)

BLOWER SELECTION GUIDE

MODEL	INPUT VOLTAGE	FUSE RATING	COMPATIBLE WITH MODELS
BA-300-115	115 VAC - 0.6A at 50-60 Hz	115 VAC - 1 A	889X-300 RF Termination 8329-300 RF Attenuators
BA-300-230	230 VAC - 0.3 A at 50/60 Hz	230 VAC - 500 mA	889X-300 RF Termination 8329-300 RF Attenuators
BA-310-115**	115 VAC - 0.6A at 50-60 Hz	115 VAC - 1 A	889X-300 RF Termination 8329-300 RF Attenuators
BA-310-230**	230 VAC - 0.3 A at 50/60 Hz	230 VAC - 500 mA	889X-300 RF Termination 8329-300 RF Attenuators

**Selectable manual or standby mode, control thermostat included.

PRODUCT FEATURES

- Self-contained instruments that require no external source of power
- Equipped with Quick-Change (QC) connectors
- Self cooling design
- Fully shielded against production of extraneous radiation
- Rugged construction

SYSTEM

Coolant Method	Oil convection-cooled
Frequency Range/VSWR	DC to 500 MHz at 1.1:1 max
Impedance	50 Ohms
Standard Attenuation Value	30 dB
Operating Position	Horizontal

ENVIRONMENTAL

Operating Temperature	-40 °C to 45 °C (-40 °F to 113 °F)
Humidity	95% non-condensing

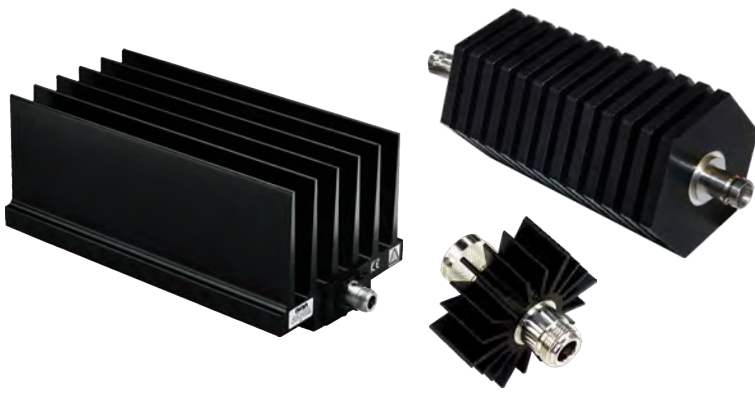

RF Power Attenuators

CONVECTION-COOLED

Bird's Convection-Cooled RF Power Attenuators are a valuable and reliable accessory for reducing power levels, for isolating components under test, for harmonic signal analysis and as comparison standards. They are world renowned for their high-quality, robust construction and conservative power ratings. These attenuators are fully shielded against production of extraneous radiation and the self-cooling design needs no cooling plate.

PRODUCT FEATURES

- Self cooling design, needs no cooling plate
- Frequencies up to 18 GHz
- Attenuator requires no AC power
- Rugged construction, fully shielded
- Full broadband operation and models to cover all LTE frequencies

SYSTEM

Coolant Method	Dry, convection-cooled
Impedance	50 Ohms
AC Power	None except 1.5 kW models require 115/230V AC power
PIM	-110 dBc min
Standard Attenuation Values	3, 6, 10, 20, 30 dB
Operating Position	Any

ENVIRONMENTAL

Ambient Temperature	-40 °C to 40 °C (-40 °F to 104 °F)
Humidity	95% non-condensing

ATTENUATOR CONFIGURATION GUIDE

POWER RATING	PRODUCT TYPE	CONNECTOR GENDER	CONNECTORS*	ATTENUATION VALUE
See selection guide	A, SA, WA = Attenuator	M/F = Male/Female F/F = Female/ Female	A = SMA B = BNC N = N T = TNC E = IEC 7/16	03 = 3 dB 06 = 6 dB 10 = 10 dB 20 = 20 dB 30 = 30 dB

*Call for custom connector options not shown in this catalog

Example: 2-A-MFB-10= Model 2-A, 2 W, A-Type Attenuator with Male/Female BNC connectors with an attenuation value of 10 dB.

Note: Not all combinations are valid. If assistance is needed consult the factory to define the model that is right for you.

ATTENUATOR SELECTION GUIDE

MODEL	POWER RATING	CONNECTORS	FREQUENCY RANGE & VSWR	DIMENSIONS	WEIGHT	FINISH
2-A	2 W	BNC, N	DC to 1 GHz @ 1.10:1 max 1 to 4 GHz @ 1.25:1 max	2.4 in x 0.8 in dia (61 mm x 21 mm dia)	3.1 oz (88 g)	Tri-Alloy
2-A	2 W	SMA	DC to 2.5 GHz @ 1.15:1 max 2.5 to 6 GHz @ 1.30:1 max	0.9 in x 0.4 in dia (23 mm x 11 mm dia)	1.2 oz (34 g)	Stainless Steel
2-6A	2 W	N	DC to 6 GHz @ 1.25:1 max	1.8 in x 0.9 in dia (46 mm x 23 mm dia)	2.5 oz (71 g)	Stainless Steel
2-18A	2 W	SMA, N	DC to 4 GHz @ 1.15:1 max 4 to 8 GHz @ 1.20:1 max 8 to 12.4 GHz @ 1.25:1 max 12.44 to 18 GHz @ 1.35:1 max	1.8 in x 0.9 in dia (46 mm x 23 mm dia)	2.5 oz (71 g)	Stainless Steel
3-A	3 W	BNC, TNC	DC to 1 GHz @ 1.10:1 max 1 to 4 GHz @ 1.25:1 max	1.5 in x 0.6 in dia (39 mm x 16 mm dia)	3.1 oz (88 g)	Tri-Alloy
5-A	5 W	BNC, N, TNC	DC to 1 GHz @ 1.10:1 max 1 to 4 GHz @ 1.25:1 max	2.6 in x 0.8 in dia (67 mm x 21 mm dia)	3.1 oz (88 g)	Tri-Alloy

RF Power Attenuators CONVECTION-COOLED

ATTENUATOR SELECTION GUIDE

MODEL	POWER RATING	CONNECTORS	FREQUENCY RANGE & VSWR	DIMENSIONS	WEIGHT	FINISH
5-6A	5 W	N	DC to 6 GHz @ 1.25:1 max	2.4 in x 0.9 in dia (61 mm x 23 mm dia)	3.0 oz (86 g)	Stainless Steel
5-18A	5 W	SMA, N	DC to 4 GHz @ 1.15:1 max 4 to 12.4 GHz @ 1.25:1 max 12.4 to 18 GHz @ 1.35:1 max	2.5 in x 0.9 in dia (64 mm x 23 mm dia)	3.5 oz (100 g)	Stainless Steel
10-A	10 W	SMA, BNC, N	DC to 1 GHz @ 1.10:1 max 1 to 4 GHz @ 1.25:1 max	2.8 in x 2.3 in dia (72 mm x 59 mm dia)	5.0 oz (142 g)	Black Anodized Aluminum
10-6A	10 W	N	DC to 4 GHz @ 1.20:1 max 4 to 6 GHz @ 1.30:1 max	2.5 in x 1.1 in dia (64 mm x 28 mm dia)	3.5 oz (100 g)	Stainless Steel
10-18A	10 W	N	DC to 4 GHz @ 1.20:1 max 4 to 12.4 GHz @ 1.30:1 max 12.4 to 18 GHz @ 1.45:1 max	2.5 in x 0.9 in dia (64 mm x 23 mm dia)	3.5 oz (100 g)	Stainless Steel
25-A	25 W	SMA, BNC, N	DC to 1 GHz @ 1.10:1 max 1 to 4 GHz @ 1.25:1 max	5.3 in x 2.3 in dia (135 mm x 59 mm dia)	9.0 oz (256 g)	Black Anodized Aluminum
25-6A	25 W	N	1 to 6 GHz @ 1.20:1 max	4.2 in x 2.3 in x 2.3 in (107 mm x 59 mm x 59 mm)	13.5 oz (383 g)	Stainless Steel
25-18A	25 W	N	DC to 4 GHz @ 1.20:1 max 4 to 12.4 GHz @ 1.30:1 max 12.4 to 18 GHz @ 1.40:1 max	4.2 in x 2.3 in x 2.3 in (107 mm x 59 mm x 59 mm)	13.5 oz (383 g)	Stainless Steel
50-A	50 W	SMA, BNC, N	DC to 1 GHz @ 1.10:1 max 1 to 3 GHz @ 1.25:1 max	6.4 in x 2.3 in dia (163 mm x 59 mm dia)	1.0 lb (454 g)	Black Anodized Aluminum
50-6A	50 W	N	DC to 6 GHz @ 1.20:1 max	4.7 in x 3.0 in x 3.0 in (120 mm x 77 mm x 77 mm)	1.7 lb (772 g)	Stainless Steel
50-18A	50 W	SMA, N	DC to 6 GHz @ 1.25:1 max 6 to 12.4 GHz @ 1.35:1 max 12.4 to 18 GHz @ 1.45:1 max	4.7 in x 3.0 in x 3.0 in (120 mm x 77 mm x 77 mm)	1.7 lb (772 g)	Stainless Steel
75-A	75 W	SMA, BNC, N	DC to 1 GHz @ 1.10:1 max 1 to 3 GHz @ 1.25:1 max	7.3 in x 2.3 in dia (186 mm x 59 mm dia)	1.6 lb (726 g)	Black Anodized Aluminum
100-A	100 W	SMA, N	DC to 1 GHz @ 1.10:1 max 1 to 3 GHz @ 1.25:1 max	7.3 in x 2.6 in x 6.4 in (186 mm x 67 mm x 163 mm)	3.6 lb (1.6 kg)	Black Anodized Aluminum
100-6A	100 W	N	DC to 2 GHz @ 1.20:1 max 2 to 4 GHz @ 1.35:1 max 4 to 6 GHz @ 1.40:1 max	6.4 in x 2.7 in x 3.8 in (163 mm x 69 mm x 97 mm)	2.4 lb (1.7 kg)	Stainless Steel
100-SA	100 W	N	DC to 1 GHz @ 1.10:1 max 1 to 2.4 GHz @ 1.25:1 max	8.4 in x 2.8 in x 2.8 in (214 mm x 72 mm x 72 mm)	3.0 lb (1.4 kg)	Black Anodized Aluminum
150-A	150 W	N	DC to 1 GHz @ 1.10:1 max 1 to 3 GHz @ 1.25:1 max	6.7 in x 2.6 in x 11.9 in (171 mm x 67 mm x 303 mm)	6.6 lb (3.0 kg)	Black Anodized Aluminum
150-SA	150 W	N	DC to 1 GHz @ 1.10:1 max 1 to 2.4 GHz @ 1.25:1 max	9.1 in x 4.0 in x 5.0 in (232 mm x 102 mm x 127 mm)	5.5 lb (2.5 kg)	Black Anodized Aluminum
150-WA	150 W	BNC, N	DC to 1 GHz @ 1.10:1 max 1 to 2.4 GHz @ 1.25:1 max	5.6 in x 5.4 in x 4.3 in (143 mm x 138 mm x 110 mm)	2.5 lb (1.2 kg)	Black Anodized Aluminum
300-A	300 W	N	DC to 1 GHz @ 1.10:1 max 1 to 2.4 GHz @ 1.25:1 max	7.3 in x 5.4 in x 10.9 in (186 mm x 138 mm x 277 mm)	12.0 lb (5.5 kg)	Black Anodized Aluminum
300-WA	300 W	N	DC to 1 GHz @ 1.10:1 max 1 to 2.4 GHz @ 1.25:1 max	9.0 in x 5.4 in x 4.8 in (229 mm x 138 mm x 122 mm)	4.6 lb (2.1 kg)	Black Anodized Aluminum
500-WA	500 W	N	DC to 1 GHz @ 1.10:1 max 1 to 2.5 GHz @ 1.25:1 max	12.4 in x 5.4 in x 4.8 in (315 mm x 138 mm x 122 mm)	7.9 lb (3.6 kg)	Black Anodized Aluminum
600-A	600 W	N	DC to 1 GHz @ 1.10:1 max 1 to 2.4 GHz @ 1.25:1 max	12.7 in x 9.4 in x 9.6 in (323 mm x 239 mm x 244 mm)	21.5 lb (9.8 kg)	Black Anodized Aluminum
1000-A*	1 kW	N	DC to 1 GHz @ 1.10:1 max 1 to 2.4 GHz @ 1.25:1 max	13.6 in x 12.8 in x 9.6 in (346 mm x 326 mm x 244 mm)	26.5 lb (12.0 kg)	Black Anodized Aluminum
1000-WA*	1 kW	N	DC to 1 GHz @ 1.10:1 max 1 to 2.4 GHz @ 1.25:1 max	19.6 in x 10.6 in x 4.8 in (498 mm x 270 mm x 122 mm)	26.5 lb (12.0 kg)	Black Anodized Aluminum
1500-WA*	1.5 kW	N	DC to 1 GHz @ 1.10:1 max 1 to 2.4 GHz @ 1.25:1 max	20.4 in x 10.7 in x 5.9 in (519 mm x 272 mm x 150 mm)	30.0 lb (13.6 kg)	Black Anodized Aluminum

*Attenuators 1 kW and above are not available in attenuation values less than 10 dB

ACCESSORIES

Precision RF Components and Accessories to Modify and Enhance Bird Products



PASSIVE COMPONENTS

Page 97 - 101



VARIABLE RF SIGNAL SAMPLERS

Page 102



COAXIAL SELECTOR SWITCH

Page 103



**QC SOLDERLESS RF
CONNECTORS**

Page 104



**ADAPTERS, CONNECTORS
& COUPLERS**

Page 105



**RF CONNECTOR &
ADAPTER KITS**

Page 106 - 108



PROTECTIVE CASES

Page 109



COAXIAL CABLES

Page 110

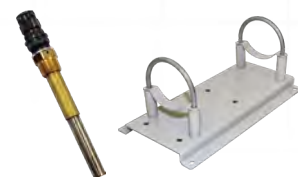

LOAD & COOLING ACCESSORIES

Page 111



PRODUCT FEATURES

- Wide frequency band of 350 to 960 MHz
- Public safety coverage
- Low passive intermodulation
- Low VSWR & high gain
- Corrosion resistant, anti-aging
- Widely used for in-building applications

Ceiling-Mount Omnidirectional Antenna

ANT-350-960-NF

This compact, omnidirectional 350-960 MHz ceiling-mount antenna provides broad coverage. It is ideally suited for communications over the UHF, 700, 800 and 900 MHz public safety bands where wide coverage is desired.

Its near-invisible design makes this RF antenna ideal for use in office environments and public buildings where reliability, durability, and aesthetics are important.

MEASUREMENT

Frequency Range	350 to 520 MHz 520 to 960 MHz
Polarization	Vertical
Gain	0.5 ±0.5 dB @ 350 to 520 MHz 1.5 ±0.5 dB @ 520 to 960 MHz
Pattern Ripple	±2 dB
Vertical Beam Width	100 ° @ 350 to 520 MHz 80 ° @ 520 to 960 MHz
VSWR	≤2.5
Rated Wind Velocity	≤2 m/s
Total Input Power	50 W
Impedance	50 Ohms
Connector	N(F)

ENVIRONMENTAL

Operating Temperature	-40 °C to 55 °C (-40 °F to 130 °F)
------------------------------	---------------------------------------

PHYSICAL

Size	Ø7.3x3.4 in (Ø185x85 mm)
Weight	.44 lb (0.20 kg)
Color	White
Material	ABS



RF Couplers

DC-450/2700-50 SERIES & PD-380/2700-200-3

For dependable support for the analysis and measurement of RF signals, Bird's RF Couplers offer a range of coupling factors, low insertion loss, and impressive accuracy.

	DC-450/2700-50 SERIES	PD-380/2700-200-3
Item Type	Directional Couplers	3dB Hybrid Coupler
Frequency Range	450 to 2700 MHz	380 to 2700 MHz
Coupling	DC-450/2700-50-4.8: 4.8 dB DC-450/2700-50-6: 6 dB DC-450/2700-50-7: 7 dB DC-450/2700-50-10: 10 dB DC-450/2700-50-15: 15 dB DC-450/2700-50-20: 20 dB	3.0 dB
Accuracy	DC-450/2700-50-4.8: ± 1.0 dB DC-450/2700-50-6: ± 1.0 dB DC-450/2700-50-7: ± 1.0 dB DC-450/2700-50-10: ± 1.4 dB DC-450/2700-50-15: ± 1.5 dB DC-450/2700-50-20: ± 1.8 dB	—
Insertion Loss	DC-450/2700-50-4.8: ≤ 2.1 dB DC-450/2700-50-6: ≤ 1.75 dB DC-450/2700-50-7: ≤ 1.45 dB DC-450/2700-50-10: ≤ 0.80 dB DC-450/2700-50-15: ≤ 0.60 dB DC-450/2700-50-20: ≤ 0.40 dB	≤ 1.0 dB
Isolation	DC-450/2700-50-4.8: ≥ 20 dB DC-450/2700-50-6: ≥ 21 dB DC-450/2700-50-7: ≥ 22 dB DC-450/2700-50-10: ≥ 27 dB DC-450/2700-50-15: ≥ 30 dB DC-450/2700-50-20: ≥ 32 dB	20 dB min
VSWR	≤ 1.30	≤ 1.25
PIM Rating	153 dBc @ 2*43 dBm	≤ -153 dBc @ 2 *43 dBm
Power	300 W avg	Average: 200 W avg RF Peak Power: 1.5 kW max
Impedance	50 Ohms	50 Ohms
Connectors	N(F)	N(F)
Color	Black	Black
Temperature Range	-35 °C to 65 °C (-31 °F to 149 °F)	-35 °C to 65 °C (-31 °F to 149 °F)
Application	IP65	Indoor & Outdoor, IP65



Power Dividers

PD-138/960-50 & PD-450/2700-300 SERIES

Bird's RF Power Dividers are world renowned for their high-quality, durable construction and conservative power ratings. Widely used for in-building applications, the line consists of power dividers in the frequency ranges of 138 to 960 MHz and 450 to 2700 MHz with low VSWR and low insertion loss characteristics.

	PD-138/960-50 SERIES	PD-450/2700-300 SERIES
Item Type	Power Dividers	Power Dividers
Frequency Range	138 to 960 MHz	450 to 2700 MHz
Number of Input Ports	1	1
Number of Output Ports	PD-138/960-50-2: 2 Ports PD-138/960-50-3: 3 Ports PD-138/960-50-4: 4 Ports	PD-450/2700-300-2: 2 Ports PD-450/2700-300-3: 3 Ports PD-450/2700-300-4: 4 Ports
Splitter Loss	PD-138/960-50-2: 3.0 dB PD-138/960-50-3: 4.8 dB PD-138/960-50-4: 6.0 dB	PD-450/2700-300-2: 3.0 dB PD-450/2700-300-3: 4.8 dB PD-450/2700-300-4: 6.0 dB
Insertion Loss	PD-138/960-50-2: 0.7 dB PD-138/960-50-3: ≤ 1.6 dB PD-138/960-50-4: ≤ 1.8 dB	PD-450/2700-300-2: ≤ 0.4 dB PD-450/2700-300-3: ≤ 0.6 dB PD-450/2700-300-4: ≤ 0.6 dB
Isolation	PD-138/960-50-2: 20 dB min PD-138/960-50-3: 18 dB min PD-138/960-50-4: 16 dB min	—
VSWR	PD-138/960-50-2: $\leq 1.3:1$ PD-138/960-50-3: $\leq 1.3:1$ PD-138/960-50-4: $\leq 1.35:1$	PD-450/2700-300-2: ≤ 1.25 PD-450/2700-300-3: ≤ 1.30 PD-450/2700-300-4: ≤ 1.30
PIM Rating	N/A	≤ -153 dBc @ 2*43 dBm
Total Input Power	50 W	300 W
Impedance	50 Ohms	50 Ohms
Connectors	N(F)	N(F)
Color	Black	Black
Temperature Range	-30 °C to 70 °C (-22 °F to 158 °F)	-35 °C to 75 °C (-31 °F to 167 °F)
Application	IP65	Indoor & Outdoor, IP65
Dimensions	PD-138/960-50-2: 6.5 in x 5.0 in x 1.0 in (158 mm x 122 mm x 24 mm) PD-138/960-50-3: 5.0 in x 6.5 in x 1.0 in (122 mm x 158 mm x 24 mm) PD-138/960-50-4: 5.0 in x 6.5 in x 1.0 in (122 mm x 158 mm x 24 mm)	—
Weight	PD-138/960-50-2: 1.8 lb (0.80 kg) PD-138/960-50-3: 1.9 lb (0.84 kg) PD-138/960-50-4: 2.0 lb (0.88 kg)	—



Power Tappers

TP-138/960-200 SERIES

Bird's RF Power Tappers are an economical and reliable alternative to directional couplers for in-building applications. Their high-quality and robust construction offer dependable bi-directional signal splitting over a broad frequency range.

	TP-138/960-200-3	TP-138/960-200-6	TP-138/960-200-10	TP-138/960-200-15	TP-138/960-200-20
Frequency Range	138 to 960 MHz	138 to 960 MHz	138 to 960 MHz	138 to 960 MHz	138 to 960 MHz
Ratio	2:1/3.0 dB nominal	4:1/6.0 dB nominal	10:1/10 dB nominal	30:1/15 dB nominal	100:1/20 dB nominal
Output Split	-1.8/-4.8 dB	-1.6/-7.0 dB	-0.9/-10.4 dB	-0.5/-15.3 dB	-0.4/-20.1 dB
Branch Flatness (Ref. to Input Level, includes Loss)					
@ 138 to 200 MHz	-7.8 dB ±0.7	-8.1 dB ±0.7	-11.0 dB ±0.8	-16.0 dB ±0.8	-20.3 dB ±1.0
@ 200 to 250 MHz	-6.8 dB ±0.6	-7.6 dB ±0.6	-10.7 dB ±0.7	-15.6 dB ±0.8	-20.1 dB ±1.0
@ 250 to 380 MHz	-6.0 dB ±0.6	-7.3 dB ±0.6	-10.3 dB ±0.7	-15.5 dB ±0.8	-20.0 dB ±1.0
@ 380 to 520 MHz	-5.5 dB ±0.6	-7.0 dB ±0.6	-10.1 dB ±0.7	-15.2 dB ±0.8	-20.1 dB ±1.0
@ 698 to 960 MHz	-4.8 dB ±0.5	-6.5 dB ±0.5	-9.9 dB ±0.5	-15.4 dB ±0.5	-21.1 dB ±1.0
Input VSWR					
@ 138 to 380 MHz max	1.4 dB	1.3 dB	1.20 dB	1.20 dB	1.20 dB
@ 380 to 960 MHz max	1.3 dB	1.25 dB	1.20 dB	1.20 dB	1.20 dB
PIM Rating	≤-153 dBc @2 *43 dBm	≤-153 dBc @2 *43 dBm	≤-153 dBc @2 *43 dBm	≤-153 dBc @2 *43 dBm	≤-153 dBc @2 *43 dBm
Average Power	200 W	200 W	200 W	200 W	200 W
Impedance	50 Ohms nominal	50 Ohms nominal	50 Ohms nominal	50 Ohms nominal	50 Ohms nominal
Connectors	N(F)	N(F)	N(F)	N(F)	N(F)
Color	Black	Black	Black	Black	Black
Temperature Range	-35 °C to 65 °C (-31 °F to 167 °F)	-35 °C to 65 °C (-31 °F to 167 °F)	-35 °C to 65 °C (-31 °F to 167 °F)	-35 °C to 65 °C (-31 °F to 167 °F)	-35 °C to 65 °C (-31 °F to 167 °F)
Humidity	5 to 95%	5 to 95%	5 to 95%	5 to 95%	5 to 95%
Application	IP65	IP65	IP65	IP65	IP65



Divider/Combiners

2-AD-FFN-2 & 30-AD SERIES

Bird's Power Combiner/Dividers are world renowned for their high-quality, robust construction and conservative power ratings.

	2-AD-FFN-2	30-AD SERIES
Divider/Combiner Type	2-Way, 2 W	2-Way, 30 W
Frequency Range	2.0 to 2.5 GHz	800 to 2400 MHz
Power Ratings	2:1/3.0 dB nominal	30 W into 1.15:1 10 W into 1.50:1 1 W into Open
Insertion Loss (above 3 dB split)	<0.2 dB	<0.5 dB
Isolation	>20 dB min, J2 to J3	>20 dB min, J2 to J3
VSWR	1.17:1 max	1.25:1 max
Matching	<1.0 Degree Phase <0.2 dB Amplitude	<2 Degree Phase (typ. 0.5 deg) <0.5 dB Amplitude
Connectors	N(F), Hermetic Flange	SMA(F), N(F)
Temperature Range	Ambient Range: -10 to 70°C	—
Environmental	Weather-tight seal All mating connectors must have weather tight gaskets	—
Housing	Aluminum, Tri-Alloy	Aluminum
Dimensions	2.75 in x 2.75 in x 1.062 in (69.85 mm x 69.85 mm x 26.92 mm)	2.25 in x 2.50 in x 1.06 in (58 mm x 64 mm x 27 mm)



Variable RF Signal Samplers

4273 & 4275 SERIES

Models 4273 and 4275 are wide range adjustable ThruLine® RF Couplers for signal observation on an oscilloscope, spectrum analyzer, or frequency counter. The output signal produced at the BNC output connector is an attenuated, unrectified signal. Both couplers have locking devices on their attenuation control.

PRODUCT FEATURES

- Very low insertion VSWR across the operating frequency range with an insertion loss less than 0.2 dB
- Available with a wide variety of Quick Change (QC) connectors
- Passive device requiring no external source of power or utility service
- Includes locking devices on the attenuation control knob

SYSTEM

Impedance	50 Ohms nominal
Finish	Bright silver plate

ENVIRONMENTAL

Ambient Temperature	-40 °C to 45 °C (-40 °F to 113 °F)
----------------------------	------------------------------------

PHYSICAL

Size	2.8 in x 2.875 in x 1.25 in (71 mm x 73 mm x 32 mm)
Weight	10 oz (280 g)

	4273	4273-020	4275	4275-020	4275-025
Power Rating	5 kW max	5 kW max	1 kW max	1 kW max	1 kW max
Frequency Range	1.5 to 35 MHz	1.5 to 35 MHz	20 to 1000 MHz	20 to 1000 MHz	20 to 1000 MHz
Insertion Loss with N Connectors	1.07 max	1.07 max	1.1 max 2 to 512 MHz 1.25 max 512 to 1000 MHz	1.1 max 2 to 512 MHz 1.25 max 512 to 1000 MHz	1.1 max 2 to 512 MHz 1.25 max 512 to 1000 MHz
Coupling	Adjustable as shown in chart within ±3 dB		N/A	N/A	N/A
Connectors	Not included, choose 2 Bird QC Type	QC Type (N) Male/Female	Not included, choose 2 Bird QC Type	QC Type (N) Male/Female	QC Type (N) Female/Female

4273 SERIES

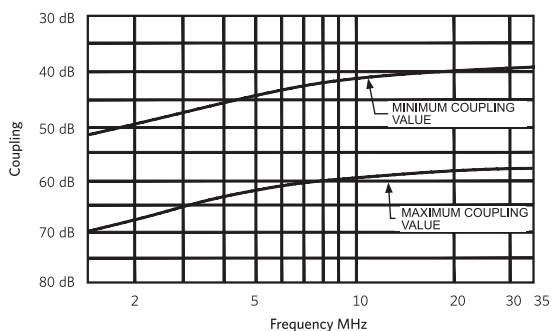

4275 SERIES

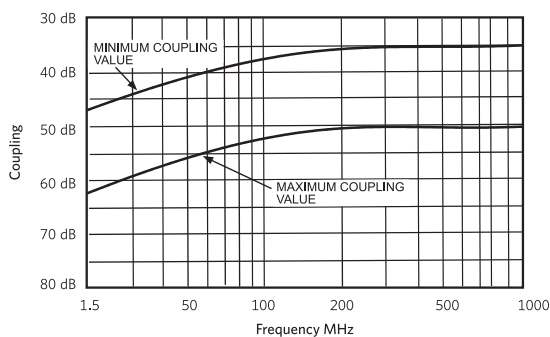



PRODUCT FEATURES

- Designed for use in switching antenna, transmitters, receivers, and other gear using 50 Ohm coaxial impedance.
- Multiple models available with options for the required number of positions and circuits
- Prevents accidental operation
- May be panel-mounted
- Rugged design for field use

Multi-Position, RF Selector Switches

COAXSWITCH SERIES

Bird's® 50 Ohm Coaxial Selector Switches employ a unique, rugged and reliable design which permits positive contact, low insertion VSWR and negligible cross talk between channels. The switching mechanism is 4 1/2 in of RG-87/U Teflon cable which is pulled away from the mating Male N connectors and rotated to the desired switch position. The design is focused on precision and requires intentional sequential movement making accidental operation impossible.

COAXSWITCH SELECTION GUIDE

MODEL	POSITIONS	COAXIAL CIRCUITS
7422	2	1
7441	3	1
7431	4	1
718	8	1
7181	10	1
72R	Reversing	2

MEASUREMENT

Frequency Range	DC to 10 GHz
VSWR	100 MHz: Negligible 1 GHz: 1.06 max 4 GHz: 1.30 max
Insertion Loss	100 MHz: 0.02 dB 1 GHz: 0.09 dB 4 GHz: 0.22 dB
RF Power	Max Rating @ 65°C 100 MHz: 850 W 1 GHz: 200 W 4 GHz: 75 W

SYSTEM

RF Voltage	500 V max
Attenuation	For unused channel - 75 dB (cross talk)

CONNECTORS

Connector	F(N)
------------------	------

ENVIRONMENTAL

Operating Temperature	-60 °C to 65 °C (-76 °F to 149 °F)
------------------------------	---------------------------------------

PHYSICAL

Weight	2.5 lb (1.1 kg)
---------------	-----------------

Quick-Change Solderless RF Connectors **QC SERIES**

Many Termaline® load resistors, attenuators and absorption wattmeters, as well as ThruLine® wattmeters, employ our patented QC-type "Quick-Change Solderless" RF Connectors. These products may be ordered with the connector (s) most convenient for use with your equipment. Many customers order additional connectors to avoid using performance robbing adapters. QC Solderless Connectors are easily changed in the field by removing and replacing four screws.

Because of the wide variety of connectors and possible applications, electrical specifications for QC-equipped products are quoted with the standard connectors normally supplied with the equipment.

 7/8 in EIA Flanged 4240-002	 LT(M) 4240-012	 LT(F) 4240-018	 LC(M) 4240-025	 LC(F) 4240-031	 UHF(F) S0239 4240-050	 N(F) 4240-062	 N(M) 4240-063
 Open Term. #10-32 Nut 4240-080	 SC(F) 4240-090	 1 5/8 in EIA Fixed(M) 4240-096	 C(F) 4240-100	 BNC(F) 4240-125	 BNC(M) 4240-132	 TNC(F) 4240-156	 TNC(M) 4240-160
 UHF(M) PL259 4240-179	 1 5/8 in EIA Swivel(M) 4240-208	 HN(F) 4240-268	 HN(M) 4240-278	 SMA(M) 4240-334	 SMA(F) 4240-336	 7/16 in IEC Type 169-4(F) 4240-344	 Mini UHF(F) 4240-346
 7/16 in IEC Type 169-4(M) 4240-363	 SQS(M) 4240-370	 SQS(F) 4240-371	 SQS(M) Polarized 4240-372	 QDS-UL(F) 4240-373	 QDS-UL(M) 4240-374	 SQS(F) Polarized 4240-375	 QRM(F) 4240-376
 GQM(F) 4240-376-10	 GQL(F) 4240-376-20	 QRM(M) 4240-377	 QRM(F) Polarized 4240-377-2	 QRM(M) Polarized 4240-378			

Adapters, Connectors & Couplers

Bird® manufactures a variety of Adapter Accessories for your application needs.

INTERSERIES RF ADAPTERS



N(M)
4240-402



N(F)
4240-403



BNC(M)
4240-404



BNC(F)
4240-405



TNC(M)
4240-406



TNC(F)
4240-407



UHF(M)
4240-408



UHF(F)
4240-409



SMA(M)
4240-410



SMA(F)
4240-411

QC SERIES, RF ADAPTERS



QC(F) to QC(F)
4240-165



3 1/8 in Flanged
to QC(F)
4240-194



1 5/8 in Flanged
to QC(F)
4240-260

FLANGE-TO-FLANGE RF ADAPTERS

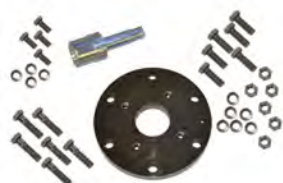

3 1/8 in Flanged To 1 5/8 in EIA
Flanged 50 Ohm
4600-025



1 5/8 in Flanged To 7/8 in EIA
Flanged 50 Ohm
4712-015

RF COUPLING KITS



7/8 in Flanged
4240-220



3 1/8 in Flanged
4600-020



1 5/8 in Flanged
4712-020



6 1/8 in Flanged
4902-020

RF Connector/Adapter Kit

MODEL 4240-400

Assemble compact, precision 50 Ohm adapters to meet up to 45 different matching requirements. The adapters offer low VSWR because of precision matching and tight mating tolerances. The kit lets you create 30 combinations and includes enough couplers to assemble 5 complete adapters at the same time.



KIT INCLUDES



(2) N(M)
4240-402



(2) N(F)
4240-403



(1) BNC(M)
4240-404



(1) BNC(F)
4240-405



(1) TNC(M)
4240-406



(1) TNC(F)
4240-407



(1) UHF(M)
4240-408



(1) UHF(F)
4240-409



(5) 50 Ohm
Couplers
4240-413

RF Interseries Adapter Kit with SMA

MODEL 4240-401

The 4240-401 RF Adapter Kit lets you assemble compact, precision 50 Ohm adapters to meet up to 45 different matching requirements. The adapters offer low VSWR because of precision matching and tight mating tolerances. Adapters and couplers are perfectly fitted in a hard carrying case.



KIT INCLUDES



(1) N(M)
4240-402



(1) N(F)
4240-403



(1) BNC(M)
4240-404



(1) BNC(F)
4240-405



(1) TNC(M)
4240-406



(1) TNC(F)
4240-407



(1) UHF(M)
4240-408



(1) UHF(F)
4240-409



(1) SMA(M)
4240-410



(1) SMA(F)
4240-411



(5) 50 Ohm
Couplers
4240-413

Aviation RF Connector/Adapter Kit

MODEL 4240-401AV

The 4240-401AV RF Adapter Kit is designed specifically for the aviation industry and allows you to assemble compact, precision 50 Ohm adapters to meet up to 45 different matching requirements. The adapters offer low VSWR because of precision matching and tight mating tolerances. Adapters and couplers are perfectly fitted in a hard carrying case.



KIT INCLUDES



(1) N(M)
4240-402



(1) N(F)
4240-403



(1) BNC(M)
4240-404



(1) BNC(F)
4240-405



(1) TNC(M)
4240-406



(1) TNC(F)
4240-407



(1) SMA(M)
4240-410



(1) SMA(F)
4240-411



(5) 50 Ohm
Couplers
4240-413



(1) C(F)
4240-418



(1) C(M)
4240-419

7/16 DIN Precision RF Adapter Kit

MODEL 4240-550

The 4240-550 RF Adapter Kit is a general purpose kit for any 7/16 DIN adapter application. Recommended use with Cable & Antenna Analyzers and features low passive intermodulation and low VSWR. Adapters are perfectly fitted in a hard carrying case.



KIT INCLUDES



(1) N(M) to
7/16 DIN(M)
PA-MNME



(1) N(M) to
7/16 DIN(F)
PA-FNFE



(1) N(F) to 7/16
DIN(M)
PA-FNME



(1) N(F) to 7/16
DIN(F)
PA-MNFE



(1) 7/16 DIN(F)
to Right Angle
7/16 DIN(M)
PA-FEME-R



(1) 7/16 DIN(F)
to 7/16 DIN(F)
PA-FEFE

4.3/10, Interseries RF Adapter Kit

MODEL 4240-560

Assemble compact, precision 50 Ohm adapters to meet up to 45 different matching requirements. The adapters offer low VSWR because of precision matching and tight mating tolerances.

KIT INCLUDES



(1) 4.3-10(F) to
4.3-10(F)
PA-F4.3F4.3



(1) 4.3-10(F) to
4.3-10(M) RA
PA-F4.3M4.3-R



(1) N(M) to
4.3-10(F)
PA-MNF4.3



(1) N(F) to 4.3-
10(M)
PA-FNM4.3



(1) N(F) to 4.3-
10(F)
PA-FNF4.3



(1) N(M) to
4.3-10(M)
PA-MNM4.3



Protective Cases

Protect and easily transport your equipment with this sturdy carrying cases from Bird®. Most carrying cases include shock-absorbing laminated die-cut foam inserts, durable polyurethane shell, folding handle and quick release latches to keep everything secure.



RF Wattmeter Hard Carrying Case, 5 Elements and 1 Small RF Load
CC-6



Plug-In Element Hard Carrying Case, 12 Elements
EC-1



RF Wattmeter Hard Carrying Case, RF Load, Signal Sampler, QC Connectors and 4 Elements
4300-061



4391A RF Power Analyst Hard Carrying Case, RF Signal Sampler and Accessories
4300A085



4410A RF Wattmeter Hard Carrying Case, RF Load, 4 Elements and Accessories
4300A055



4421A RF Wattmeter Hard Carrying Case, 4 RF Power Sensors and Accessories
4300B215



RF Digital Power Meter and Antenna Tester Hard Carrying Case
5000-035



FlightHawk™ Hard Carrying Case
FH-AV-CC



5000-NG Premium Carrying Case
5B5000-1

RF Coaxial Cables **DC SERIES**

Bird® provides a wide selection of cable assemblies to suit any RF application. For use with Bird's Wattmeters and Watcher Series Monitors.



14 in DC to BNC(M)
Group I
3170-058-1



25 ft DC to BNC(M)
Group I
3170-058-3



50 ft DC to BNC(M)
Group I
3170-058-5



100 ft DC to BNC(M)
Group I
3170-058-9



12 in DC to Snap Spade
Group II
4220-097-1



10 ft DC to Snap Spade
Group II
4220-097-7



25 ft DC to Snap Spade
Group II
4220-097-10



50 ft DC to Snap Spade
Group II
4220-097-17



75 ft DC to Snap Spade
Group II
4220-097-13



100 ft DC to Snap Spade
Group II
4220-097-16



39.5 in DC to DC Connector
Group III
7500-072-1



10 ft DC to DC Connector
Group III
7500-072-4

Load & Cooling Accessories

Bird® manufactures a variety of RF Termination Accessories for your Bird® Products.



THERMOSWITCHES FOR AIR-COOLED LOADS

PART#	FUNCTION	TEMP. SET POINT	USE WITH
8890-008	Over Temp. Interlock	Opens at 236 °C	8890 and 8920 Series
8890-017	Over Temp. Interlock	Opens at 226 °C	8930 Series
8892-333	Blower	Opens at 60 °C	8930 Series



WATER-COOLED LOAD ACCESSORIES

PART#	DESCRIPTION	USE WITH
RPK6770A120	RF Termination Wall Mount Bracket	8730 Econoload Series (10 kW)
RPK5-898-6	Water Flow Switch	10 kW Econoload Series
RPK5-898-2	Water Flow Switch	20 kW Econoload Series
RPK5-898-3	Water Flow Switch	30 kW Econoload Series



LIQUID COOLANTS*

PART#	DESCRIPTION	VOLUME/PKG.
5-030-3	Refined Mineral Oil	1 Gallon (3.79 L)
5-1070-2	PMX-200, Silicone Oil	1 Gallon (3.79 L)
5-1070-3	PMX-200, Silicone Oil	5 Gallon (18.93 L)
5-1134-3	Ethylene Glycol, Industrial Grade	1 Gallon (3.79 L)

*Includes SDS sheet with shipment

REPLACEMENT RESISTORS

PART#	USE WITH
8731-031-1	8731 Econoload Series (10 kW)
RPK8738A072	8730A/8738A Econoload Series (10 kW)
RPK8755-027-2	8745/8746 Econoload Series (20 kW)
RPK8755-027-3	8755/8756 Econoload Series (30 kW)
RPK8755-027-4	8765/8766 Econoload Series (40 kW)
RPK8755-027-5	8775/8776 Econoload Series (50 kW)
RPK8792-010-1 one reqd.	8792 Econoload Series (80 kW)
RPK5A2388	8578A100 Forced-Air Load (10 kW)

DOLLIES

PART#	DESCRIPTION
6771-011	For 10 and 25 kW Moduload
6772B011	For 50 kW Moduload
6773-011	For 892X, 893X Oil Loads



SOFTWARE

Enhance the Management and Performance of Bird RF Sensor and Monitor Products

Bird has developed intuitive and flexible software applications that provide set up and monitoring of a wide range of Bird RF sensor and monitor products. The Bird RF Meter App is ideal for field use, turning an Android phone into a power meter capable of connecting with and monitoring Bird USB Field Sensors. The VPM3, Virtual Power Meter Software is a true Windows application allowing for simultaneous management and logging of multiple sensors from the desktop.



BIRD RF METER APP

[Page 113](#)



VPM3

[Page 113](#)

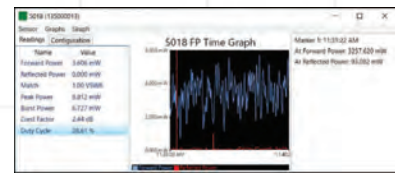

WINDOWS® 10 RF METER APP

[Page 114](#)



Bird RF Meter App

RF METER APP FOR BIRD USB FIELD POWER SENSORS

Ideally suited for field techs and engineers who need to make power measurements anywhere they go. The RF Meter's mobile interface has an intuitive, menu-driven design making it easy to use. Utilizing an Android phone and downloading the RF Meter App from the Google Play store, you can pair and set up a Bird sensor with the appropriate configurations, correction factors, offsets and zero calibration. The app also includes the ability to enable smoothing level for more stable readings or max hold to detect the maximum measured power.

The RF Meter App is available for download from the Bird website for a PC running Windows 10.

PRODUCT FEATURES

- Automatically detects sensor and opens the application
- Identifies multiple sensors and saves session information
- Displays only the information appropriate to sensor indicated
- Digital Display function, bar and time graphing and logging capabilities
- Share results directly to messaging, email or WiFi printer.
- Plug and Play in Seconds
- Displayable Parameters (sensor dependent): True Average Power (Forward and Reflected), VSWR, Return Loss, rho, Match Efficiency, Peak Power, Peak to Average Ratio, Crest Factor, PEP, CDF, CCDF, Confidence %, Burst and Burst Average Power, IEEE 194 Pulse Parameters, Sensor temperature.

COMPATIBLE DEVICES

- Power Sensors: 5012D, 5014, 5016D, 5017D, 5017D-AV, 5018D, 5019D, 7020 Series, 7022 Series
- Power Monitors: 4042, 4043, 4044, 4045, 3141 Channel Power Monitor, ACM Series, BPME Series

SYSTEM REQUIREMENTS

- Android version 4.0.3 or higher
- Hardware must support On-The-Go (OTG) host functionality
- Available through Google Play

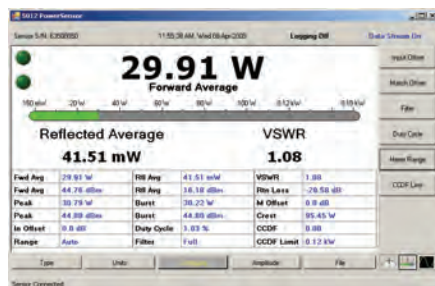

Virtual RF Power Meter Software

VPM3

The VPM3, Virtual Power Meter is a Microsoft Windows® RF power measurement application with advanced functionality. Compatible with a full range of Bird RF Power Sensors, the program integrates data logging in XML or CSV formats and the ability to manage multiple sensors simultaneously.

PRODUCT FEATURES

- Manage up to 50 sensors simultaneously
- Multiple display functions: digital, analog and strip chart
- Each display screen can be customized for user preference
- Functions: True Average Power (Forward and Reflected), VSWR, Peak Power, Crest Factor, CCDF, Burst Power
- True Windows application
- Data logging capability with playback of saved log files
- Snapshot capabilities
- Ideal for use as a system component
- No calibration required
- Plug-and-play in seconds

COMPATIBLE DEVICES

- Power Sensors: 5012D, 5014, 5016D, 5017D, 5017D-AV, 5018D, 5019D, 7020, 7022

SYSTEM REQUIREMENTS

- Windows 7 SP1
- Internet Explorer or equivalent
- Adobe Reader
- 1280 x 720, 16 bit or higher resolution recommended
- 100 MB free disk space
- 1 available USB port
- Mouse or pointing device

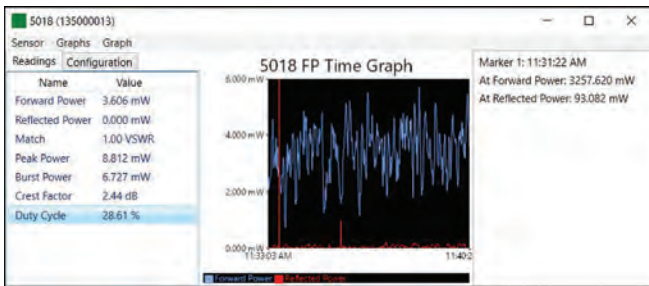

Bird RF Meter - Windows®10

RF METER APP FOR USE WITH WINDOWS®10

Ideally suited for field techs and engineers who need to make power measurements utilizing a PC or laptop running Microsoft Windows®10. Installation is fast and easy requiring only a connection of the power sensor to the windows PC with RF Meter App Installed.

The RF Meter App is available for download from the Bird website for a PC running Windows 10.

PRODUCT FEATURES

- 100% compatible with all USB power sensors & Windows 10
- Functions: True Average Power (Forward and Reflected), VSWR, Peak Power, Crest Factor, CCDF, Burst Power (sensor dependent)
- True Windows Application
- Offset, smoothing & scaling
- Data logging capability
- Time & Bar graphing display & markers
- Snapshot & sharing capabilities
- No calibration require
- Plug to Play in seconds

COMPATIBLE DEVICES

- Power Sensors: 5012D, 5014, 5015, 5015-EF, 5016D, 5017D, 5018D, 5019D, 7020, 7022

SYSTEM REQUIREMENTS

- Windows 10
- Adobe Reader
- 1280 x 720, 16 bit or higher resolution recommended
- 100 MB free disk space
- 1 available USB port
- Mouse or pointing device

Index

1J-950	73	25-A	95	100B3	77
1J-1100	73	25A	72	100B12	76
2.5J-950	73	25B	72	100C	72
2.5J-1100	73	25C	72	100C1	76
2-6A	94	25-CT	83	100C12	76
2-18A	94	25D	72	100-CT	83
2-18T	84	25E-400	72	100D	72
2-A	94	25E-800	72	100E-400	72
2-AD-FFN-2	101	25H	72	100E-800	72
2-NT	84	25J-950	73	100H	72
2-T	84	25J-1100	73	100J-950	73
3-A	94	25KB1	76	100J-1100	73
4.3/10, Interseries RF Adapter Kit	108	25KB3	77	100KH3	77
5-6A	95	25KC3	77	100KH6	77
5-18A	95	25KH1	76	100-NST	85
5-18T	84	25KH3	77	100-SA	95
5-030-3	111	25KH6	77	100-ST	85
5-1070-2	111	25KH12	76	100-T	85
5-1070-3	111	25-T	85	110-1	72
5-1134-3	111	030-2	72	150-1	72
5-A	94	30-AD Series	101	150-2	72
5A	72	040-1	72	150-A	95
5B	72	040-2	72	150-SA	95
5B5000-1	109	43	63	150-ST	85
5C	72	43P	63	150-T	85
5D	72	050-1	72	150-WA	95
5E-400	72	050-2	72	150-WT	85
5E-800	72	50-6A	95	151-CT	83
5J-950	73	50-6T	85	200-1	72
5J-1100	73	50-18A	95	200-2	72
5-NT	84	50-18T	85	250-2	72
5-T	84	50-A	95	250A	72
7/16 DIN Precision RF Adapter Kit	107	50A	72	250B	72
10-6A	95	50B	72	250B1	76
10-18A	95	50C	72	250B3	77
10-A	95	50-CT	83	250B12	76
10A	72	50D	72	250C	72
10B	72	50E-400	72	250C1	76
10C	72	50E-800	72	250C3	77
10D	72	50H	72	250C12	76
10E-400	72	50J-950	73	250-CT	83
10E-800	72	50J-1100	73	250D	72
10J-950	73	50KB3	77	250E-400	72
10J-1100	73	50KH1	76	250E-800	72
10KB1	76	50KH3	77	250H	72
10KB3	77	50-NT	85	250J-950	73
10KB12	76	50-T	85	250J-1100	73
10KC1	76	060-1	72	275-1	72
10KC3	77	060-2	72	300-A	95
10KH1	76	72R	103	300B1	76
10KH3	77	75-A	95	300-CT	83
10KH6	77	75-T	85	300-T	85
10KH12	76	080-1	72	300-WA	95
10-T	85	080-2	72	300-WT	85
15KB1	76	095-1	72	400-2	72
15KB3	77	095-2	72	400-50	75
15KH1	76	100-6A	95	400-75	75
025-2	72	100-6T	85	400-125	75
25-6A	95	100-A	95	400-225	75
25-6T	85	100A	72	400-400	75
25-18A	95	100B	72	400-750	75
25-18T	85	100B1	76	425-1	72

430-2.....	74	606-50.....	75	3170-058-3.....	110
430-3.....	74	606-400.....	75	3170-058-5.....	110
430-7.....	74	718.....	103	3170-058-9.....	110
430-8.....	74	801-1.....	72	4020 Series.....	29
430-13.....	74	801-2.....	72	4021.....	29
430-16.....	74	1000-A.....	95	4022.....	29
430-20.....	74	1000A.....	72	4023A3G.....	29
430-22.....	74	1000B.....	72	4024.....	29
430-26.....	74	1000B1.....	76	4025.....	29
430-27.....	74	1000B3.....	77	4027A2M.....	26
430-28.....	74	1000B12.....	76	4027A4M.....	26
430-33.....	74	1000C.....	72	4027A12M.....	26
430-48.....	74	1000C1.....	76	4027A250K.....	26
430-57.....	74	1000C3.....	77	4027A400K.....	26
430-61.....	74	1000C12.....	76	4027A800K.....	26
430-65.....	74	1000D.....	72	4027A Series.....	26
430-86.....	74	1000E-400.....	72	4027F2M.....	27
430-157.....	74	1000E-800.....	72	4027F10M.....	27
430-205.....	74	1000H.....	72	4027F60M.....	27
430-208.....	74	1000H1.....	76	4027F Series.....	27
430-217.....	74	1000H12.....	76	4028A2M.....	28
430-247.....	74	1000J-950.....	73	4028A3M.....	28
430-248.....	74	1000J-1100.....	73	4028A4M.....	28
430-249.....	74	1000P.....	73	4028A10M.....	28
430-253.....	74	1000-T.....	85	4028A25M.....	28
430-254.....	74	1000-WA.....	95	4028A250K.....	28
430-255.....	74	1000-WT.....	85	4028A400K.....	28
430-256.....	74	1500B1.....	76	4028B3M.....	28
430-258.....	74	1500B3.....	77	4028B10M.....	28
430-263.....	74	1500H1.....	76	4028C10M.....	28
430-264.....	74	1500-W.....	85	4028 Series.....	28
430-265.....	74	1500-WA.....	85, 95	4042E Series.....	52-53
500A.....	72	2500A.....	72, 74	4042 Series.....	52
500B.....	72	2500B.....	72, 74	4043E Series.....	52-53
500B1.....	76	2500B1.....	76	4043 Series.....	52
500B3.....	77	2500B3.....	77	4044 Series.....	52
500B12.....	76	2500B12.....	76	4210A100.....	71
500C.....	72	2500C.....	72, 74	4220-097-1.....	110
500C1.....	76	2500C1.....	76	4220-097-7.....	110
500C3.....	77	2500C3.....	77	4220-097-10.....	110
500-CT.....	83	2500C12.....	76	4220-097-13.....	110
500D.....	72	2500D.....	72	4220-097-16.....	110
500E-400.....	72	2500E-400.....	72, 74	4220-097-17.....	110
500E-800.....	72	2500E-800.....	72, 74	4230-006-1.....	70
500H.....	72	2500H.....	72	4230-018.....	70
500H12.....	76	2500H1.....	76	4230-057.....	70
500J-950.....	73	2500H3.....	77	4230-059.....	70
500J-1100.....	73	2500H12.....	76	4240-002.....	104
500-WA.....	95	2500J-950.....	73	4240-012.....	104
500-WT.....	85	2500J-1100.....	73	4240-018.....	104
501-50.....	75	2500P.....	73	4240-025.....	104
501-75.....	75	3000B1.....	76	4240-031.....	104
501-125.....	75	3000H1.....	76	4240-050.....	104
501-225.....	75	3127-040.....	68	4240-062.....	104
501-400.....	75	3127-075.....	68	4240-063.....	104
553-50.....	75	3127A Series.....	58	4240-080.....	104
553-75.....	75	3127 Series.....	68	4240-090.....	104
553-125.....	75	3128A Series.....	58	4240-096.....	104
553-401.....	75	3141A15.....	51	4240-100.....	104
600-A.....	95	3141A48.....	51	4240-125.....	104
600B1.....	76	3141 Series.....	51	4240-132.....	104
600-T.....	85	3170-058-1.....	110	4240-156.....	104

4240-160.....	104	4431.....	63	7001A900-3.....	31
4240-165.....	105	4522A002-5.....	70	7001B040-5M.....	31
4240-179.....	104	4526.....	69	7003A001.....	17
4240-194.....	105	4527.....	69	7020-1-010101.....	44
4240-208.....	104	4600-020.....	105	7020-1-020101.....	44
4240-220.....	105	4600-025.....	105	7020-1-030301.....	44
4240-260.....	105	4610-000.....	70	7020 Series.....	44
4240-268.....	104	4642-010.....	70	7022-1-020201.....	45
4240-278.....	104	4712-015.....	105	7027 Series.....	25
4240-334.....	104	4712-020.....	105	7037 Series.....	24
4240-336.....	104	4715-000.....	70	7181.....	103
4240-344.....	104	4723-000.....	70	7422.....	103
4240-346.....	104	4723-020.....	70	7431.....	103
4240-363.....	104	4801-100.....	70	7441.....	103
4240-370.....	104	4802-000.....	70	7500-072-1.....	110
4240-371.....	104	4902-020.....	105	7500-072-4.....	110
4240-372.....	104	4905-000.....	70	8135.....	86
4240-373.....	104	4909-000.....	70	8141.....	86
4240-374.....	104	5000-035.....	109	8201.....	86
4240-375.....	104	5000A.....	72, 74	8251.....	86
4240-376.....	104	5000B.....	72, 74	8251D.....	88
4240-376-10.....	104	5000B1.....	76	8251D7-16.....	88
4240-376-20.....	104	5000B3.....	77	8325.....	93
4240-377.....	104	5000B12.....	76	8327-300.....	93
4240-377-2.....	104	5000C.....	72, 74	8329-300.....	93
4240-378.....	104	5000C1.....	76	8329-300 w/ BA-300-115.....	93
4240-400.....	106	5000C3.....	77	8329-300 w/ BA-300-230.....	93
4240-401.....	106	5000D.....	72	8401.....	86
4240-401AV.....	107	5000E-400.....	72, 74	8631B115.....	92
4240-402.....	105	5000E-800.....	72, 74	8631B230.....	92
4240-403.....	105	5000H.....	72	8635B115.....	92
4240-404.....	105	5000H1.....	76	8635B230.....	92
4240-405.....	105	5000H3.....	77	8645B115.....	92
4240-406.....	105	5000H12.....	76	8645B230.....	92
4240-407.....	105	5000J-950.....	73	8645B230-6.....	92
4240-408.....	105	5000J-1100.....	73	8655B115-6.....	92
4240-409.....	105	5000-NG.....	41	8655B230-5.....	92
4240-410.....	105	5000P.....	73	8655B230-6.....	92
4240-411.....	105	5012D.....	42	8720.....	89
4240-550.....	107	5014.....	46	8726.....	89
4240-560.....	108	5016D.....	42	8730A.....	89
4273.....	102	5017D.....	42	8731.....	89
4273-020.....	102	5017D-AV.....	42	8731-031-1.....	111
4273 Series.....	102	5018D.....	42	8738A.....	89
4274-025.....	74	5019D.....	42	8745.....	89
4274-050.....	74	6000B1.....	76	8746.....	89
4275.....	102	6000H1.....	76	8755.....	89
4275-020.....	102	6771-011.....	111	8756.....	89
4275-025.....	102	6772B011.....	111	8765.....	89
4275 Series.....	102	6773-011.....	111	8775.....	89
4300-061.....	109	6810-220.....	67	8776.....	89
4300A055.....	109	6810-230.....	67	8792.....	89
4300A085.....	109	6810-250.....	67	8860.....	86
4300B215.....	109	6810-265.....	67	8861.....	86
4304A.....	63	6810-307.....	67	8862.....	86
4314C.....	63	6810-309-7.....	67	8865SC13.....	88
4391A.....	63-66	6810 Series.....	67	8890-008.....	111
4410A.....	63-64	7001A500-1-2.....	31	8890-017.....	111
4421A-10-00-0.....	23	7001A500-1-xyyy.....	31	8890-300.....	87
4421A-10-11-0.....	23	7001A550-1-xx yy.....	31	8890-300SC13.....	88
4421A-20-00-0.....	23	7001A550-2.....	31	8890-315.....	87
4421A-20-11-0.....	23	7001A900-2.....	31	8890-320.....	87

8891-315.....87
 8891-320.....87
 8891D300.....88
 8892-300.....87
 8892-315.....87
 8892-320.....87
 8892-333.....111
 8892D300.....88
 8892D320.....88
 8895-300.....87
 8895-315.....87
 8895-320.....87
 8921.....87
 8921SC13.....88
 8922.....87
 8922D.....88
 8926.....87
 8926D.....88
 8927D.....88
 8931-115.....87
 8931-115SC13.....88
 8931-230.....87
 8931-230SC13.....88
 8932-115.....87
 8932-230.....87
 8936-115.....87
 8936-230.....87
 8936D115.....88
 8936D230.....88
 8941-115SC13.....88
 8941-230SC13.....88
 10000B.....74
 10000E-400.....74
 10000E-800.....74
 10000H.....74
 10000P.....73

A

Accessories.....96
 Adapters, Connectors & Couplers.....105
 ANT-350-960-NF.....97
 APM-1B.....47, 65
 APM-1C.....47, 65
 APM-1E-400.....47, 65
 APM-1E-800.....47, 65
 APM-2.5B.....47, 65
 APM-2.5D.....47, 65
 APM-2.5E-400.....47, 65
 APM-2.5E-800.....47, 65
 APM-5A.....47, 65
 APM-5B.....47, 65
 APM-5C.....47, 65
 APM-5D.....47, 65
 APM-5E-400.....47, 65
 APM-5E-800.....47, 65
 APM-5H.....47, 65
 APM-10A.....47, 65
 APM-10B.....47, 65
 APM-10C.....47, 65
 APM-10D.....47, 65
 APM-10E-400.....47, 65

APM-10E-800.....47, 65
 APM-10H.....47, 65
 APM-16.....62-63, 65
 APM-25B.....47, 65
 APM-25C.....47, 65
 APM-25D.....47, 65
 APM-25E-400.....47, 65
 APM-25E-800.....47, 65
 APM-50C.....47, 65
 APM-50D.....47, 65
 APM-50E-400.....47, 65
 APM-50E-800.....47, 65
 APM-100A.....47, 65
 APM-100B.....47, 65
 APM-100C.....47, 65
 APM-100D.....47, 65
 APM-100H.....47, 65
 APM-250A.....47, 65
 APM-250B.....47, 65
 APM-250C.....47, 65
 APM-250D.....47, 65
 APM-250E-400.....47, 65
 APM-250E-800.....47, 65
 APM-250H.....47, 65
 APM-500B.....47, 65
 APM-500C.....47, 65
 APM-500D.....47, 65
 APM-500E-400.....47, 65
 APM-500E-800.....47, 65
 APM-500H.....47
 APM-1000B.....47, 65
 APM-1000C.....47, 65
 APM-1000H.....47, 65
 Average Reading RF Power Meter.....65
 Aviation RF Connector/Adapter Kit.....107

B

BA-300-115.....93
 BA-300-230.....93
 BA-310-115.....93
 BA-310-230.....93
 Basic Power Sensors.....44
 BDS2.....30
 Bird Diagnostic System.....30
 Bird RF Meter App.....113
 Bird RF Meter - Windows 10.....114
 BPME Series.....56
 Broadcast Power Monitor.....56

C

CC-6.....109
 Channel Power Monitor.....51
 Coaxial Cables.....110
 Coaxwich Series.....103
 Conduction-Cooled RF Power Loads.....83
 Convection-Cooled RF Power Attenuators...94
 Convection-Cooled RF Power Loads.....84
 CPM Series.....51

D

DA5F15.....91
 DA5F30.....91
 DA5U15.....91
 DA5U30.....91
 DA10F15.....91
 DA10F30.....91
 DA10U15.....91
 DA10U30.....91
 DA10V1F15.....90
 DA10V1F30.....90
 DA10V1U15.....90
 DA10V1U30.....90
 DA10V3F15.....90
 DA10V3F30.....90
 DA10V3U15.....90
 DA10V3U30.....90
 DA15F15.....91
 DA15F30.....91
 DA15U15.....91
 DA15U30.....91
 DA25-4U15.....91
 DA25-4U30.....91
 DA25F15.....91
 DA25F30.....91
 DA25 to 4U15.....91
 DA25 to 4U30.....91
 DA25U15.....91
 DA25U30.....91
 DA25V3F15.....90
 DA25V3F30.....90
 DA25V3U15.....90
 DA25V3U30.....90
 DA25V4U15.....90
 DA25V4U30.....90
 DA40-5U15.....91
 DA40-5U30.....91
 DA40F15.....91
 DA40F30.....91
 DA40 to 5U15.....91
 DA40 to 5U30.....91
 DA40U30.....91
 DA Series.....90
 DC-450/2700-50 Series.....98
 Digital Air Loads.....90
 Directional Coupler Elements.....75
 Directional ThruLine® Power Sensors.....46
 Divider/Combiners.....101
 Dollies.....111
 Dual Element, Single Carrier
 RF Monitor/Alarm.....59
 Dual Meter, Dual Element, Panel-Mount RF
 Wattmeters.....69
 Dual Sensor Calibration Cart.....34

E

EC-1.....109
 Ethernet Power Sensors.....52,53

F

FH-AV-BASIC.....	18
FH-AV-CC.....	109
FH-AV-KIT.....	18
Field Replacement Meter Movement Assembly Kit.....	71
Flange-to-Flange RF Adapters.....	105
FlightHawk Aviation Cable & Antenna Analyzer Kit.....	18
Forced Air-Cooled Moduloads.....	92

G

General Purpose RF Test Kits.....	17
-----------------------------------	----

H

High-Frequency Elements.....	73
High Power Calibration Cart.....	36

I

Inline VI Probe System.....	30
Interseries RF Adapters.....	105

L

Liquid Coolants.....	111
Load & Cooling Accessories.....	111
Low-Frequency Elements.....	73
Low-Power Elements.....	72

M

Master RF Test Kits.....	16
Milliwatt Elements.....	74
Model 43 Series.....	62
Model 44 Series.....	62-63
Model 3140A4.....	57
Model 3170B.....	59
Model 4240-400.....	106
Model 4240-401.....	106
Model 4240-401AV.....	107
Model 4240-550.....	107
Model 4240-560.....	108
Model 4526.....	69
Model 4527.....	69
MSCC7 Series.....	34
Multifunction Power Meters.....	23
Multi-Position, RF Selector Switches.....	103
Multipower RF Wattmeters.....	64

N

Nondirectional Sampler Elements.....	74
--------------------------------------	----

O

Oil Convection-Cooled RF Power Attenuators.....	93
Oil-Cooled Market Specific RF Loads.....	88
Oil-Cooled RF Loads.....	86

P

PA-F4.3F4.3.....	108
PA-F4.3M4.3-R.....	108
PA-FNF4.3.....	108
PA-FNM4.3.....	108
PA-MNF4.3.....	108
PA-MNM4.3.....	108
PD-138/960-50 Series.....	99
PD-380/2700-200-3.....	98
PD-450/2700-300 Series.....	99
PEP-Dual Element, RF Power Analyst.....	66
Plug-In Elements.....	72-74, 76-77
Portable ThruLine Wattmeters.....	62
Power Dividers.....	99
Power Tappers.....	100
Precision Directional RF Power Sensors.....	26
Precision Filtered RF Power Sensors.....	27
Precision RF Power Sensors.....	24-25
Precision RF Products.....	20
Protective Cases.....	109
Pulse-Power Elements.....	74

Q

QC Series.....	104
QC Series, RF Adapters.....	105
Quick-Change Solderless RF Connectors.....	104

R

RailHawk Railway Cable & Antenna Analyzer Kit.....	19
Replacement Meter Movement Face.....	71
Replacement Resistors.....	111
RF Analyzers.....	10
RF Calibration Kit.....	37
RF Coaxial Cables.....	110
RF Connector/Adapter Kit.....	106-108
RF Couplers.....	98
RF Coupling Kits.....	105
RF Directional ThruLine Power Sensors.....	28-29
RF Interseries Adapter Kit with SMA.....	106
RF Loads & Attenuators.....	78
RF Power Meter Display.....	41
RF Power Meters.....	60
RF Power Monitors.....	48
RF Power Sensors.....	38
RF Wattmeter Movement Kit.....	71
RH-RR-KIT.....	19
Rigid Line Sections.....	70
Rigid Line Wattmeters.....	67-68
RPK5-898-2.....	111
RPK5-898-3.....	111
RPK5-898-6.....	111
RPK5A2388.....	111
RPK43-4.....	71
RPK2080-002.....	71
RPK6770A120.....	111
RPK8738A072.....	111
RPK8755-027-2.....	111

RPK8755-027-3.....	111
RPK8755-027-4.....	111
RPK8755-027-5.....	111
RPK8792-010-1.....	111

S

SCC7 Series.....	32
SCC8 Series.....	36
SH-605-AOA.....	15
SH-605-TC.....	15
SH-755-AOA.....	15
SH-755-TC.....	15
SignalHawk Spectrum Analyzers.....	15
Single Carrier RF Monitors/Alarms.....	58
Single Sensor Calibration Cart.....	32
SiteHawk Cable & Antenna Analyzers.....	14
SK-4500-TC.....	14
SK-6000-TC.....	14
SK-9000-TC.....	14
SK-SH-KIT.....	16
SMK-3000 Series.....	37
SMK-3003-HB.....	37
SMK-3003-LB.....	37
SMK-3003-MB.....	37
Software.....	112
Statistical Power Sensor.....	45

T

Thermoswitches for Air-Cooled Loads.....	111
ThruLine Wattmeter Components.....	70
TP-138/960-200-3.....	100
TP-138/960-200-6.....	100
TP-138/960-200-10.....	100
TP-138/960-200-15.....	100
TP-138/960-200-20.....	100
TP-138/960-200 Series.....	100
TPM1.....	54
TPM3.....	54
TPM Series.....	54
Transmitter Power Monitor.....	54
Transmitter RF Power Monitor Display.....	57

V

Variable RF Signal Samplers.....	102
Virtual RF Power Meter Software.....	113
VPM3.....	113

W

Water-Cooled Econoloads.....	89
Water-Cooled Load Accessories.....	111
Wideband Power Sensors.....	42



Since 1942, Bird has been developing and manufacturing cutting-edge, high power RF sensors, test equipment, and RF coverage products that engineers, field techs, and manufacturers worldwide, rely on for accuracy, precision, and dependability. Bird continues to innovate precision and performance products for public safety, cellular, semiconductor, military, aviation, broadcast, and medical markets.

The past 80 years have brought many changes. However, Bird remains as committed today as we were in 1942 to a continuous improvement culture, innovative products that please our customers, and a dedication to advancing RF for tomorrow's applications.

The **RF** Experts | USA Sales: 30303 Aurora Rd, Solon, OH 44139 | www.birdrf.com
Phone: +1 440.248.1200 / 866.695.4569 [Toll Free]

Bird is not responsible for omissions or errors. Specifications subject to change without notice.
©2023 Bird ■ Test-Measurement-Catalog-07132023

